

RM-140

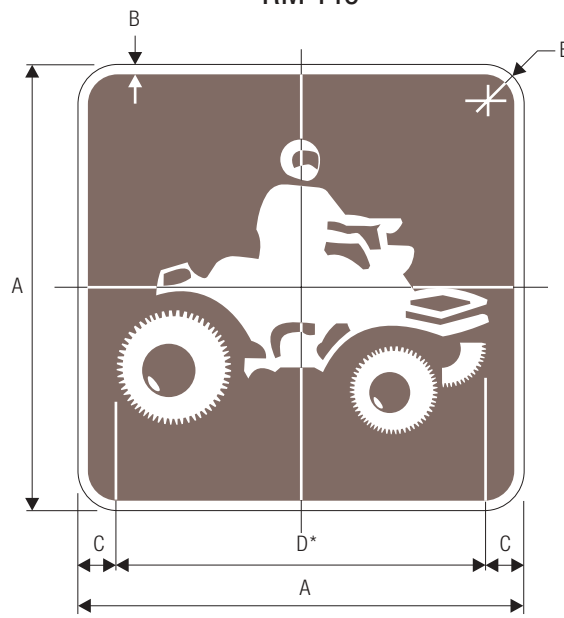

RL-170

* The largest dimension of most symbols should be about 83.5% of the total sign width. Symbols for showers, trailer sanitary stations, boat tours, interpretative trails, and climbing areas should extend near or into the sign border as shown in the grid layouts.

A	B	C	D	E
150	6	12	126	30
225	10	18	189	30
300	10	25	250	40
450	10	37	376	40
600	15	50	500	50
750	20	62	626	50

COLORS: LEGEND – WHITE (RETROREFLECTIVE)
BACKGROUND – BROWN

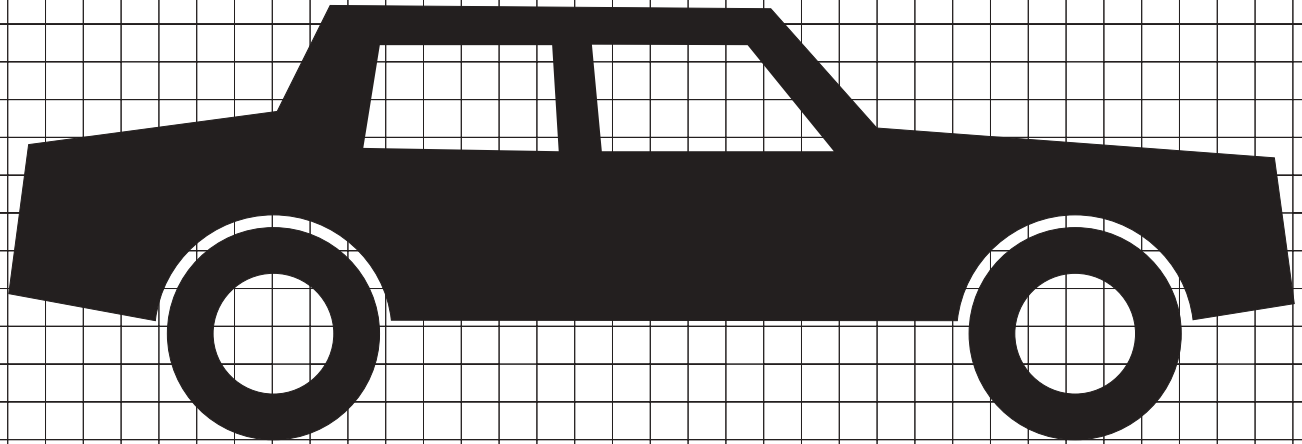

RG-010

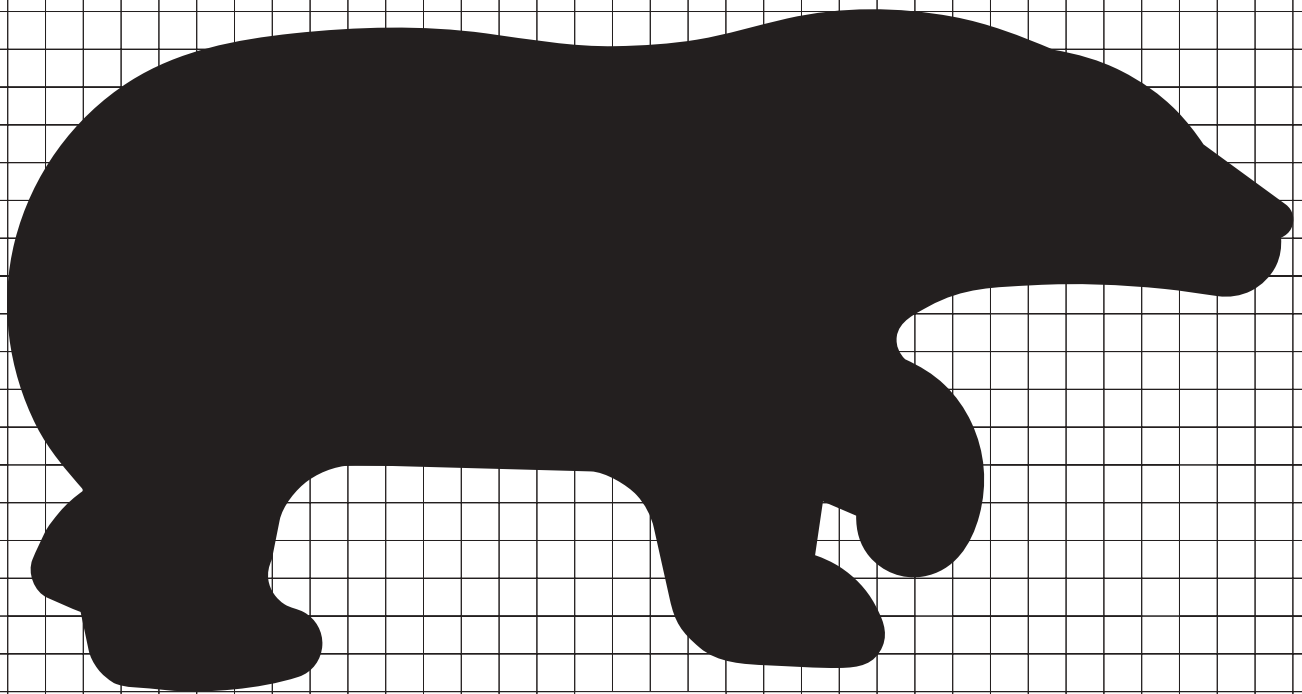

RG-020

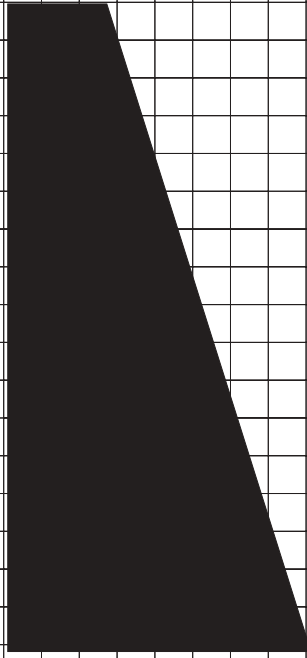
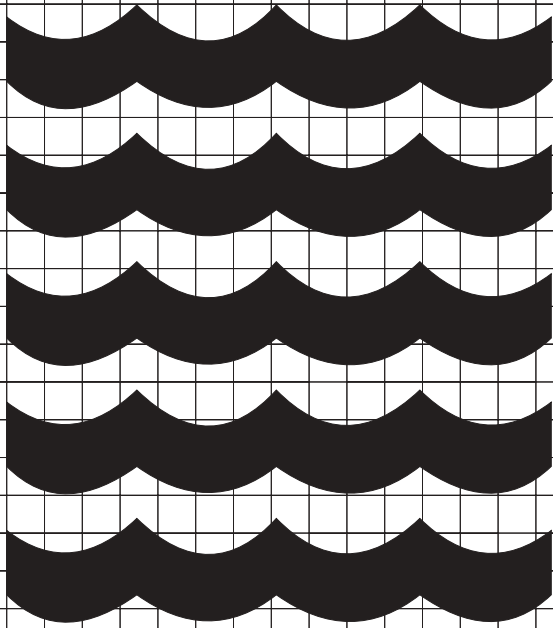

RG-030

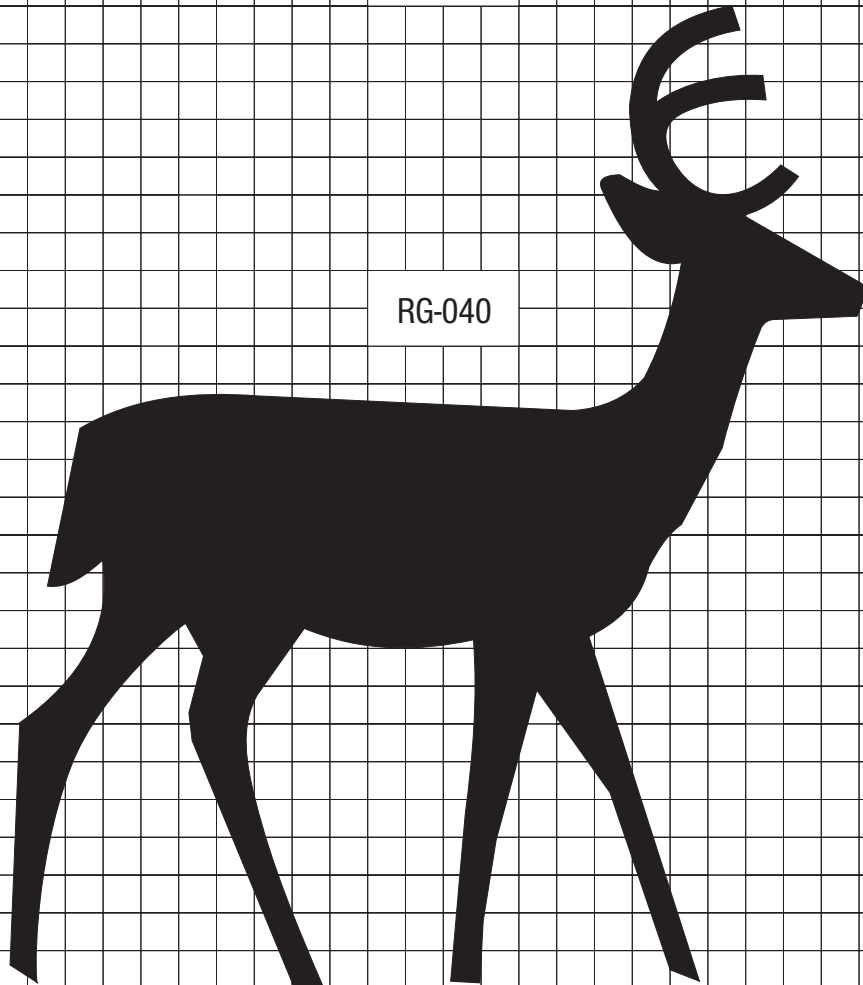

RG-040

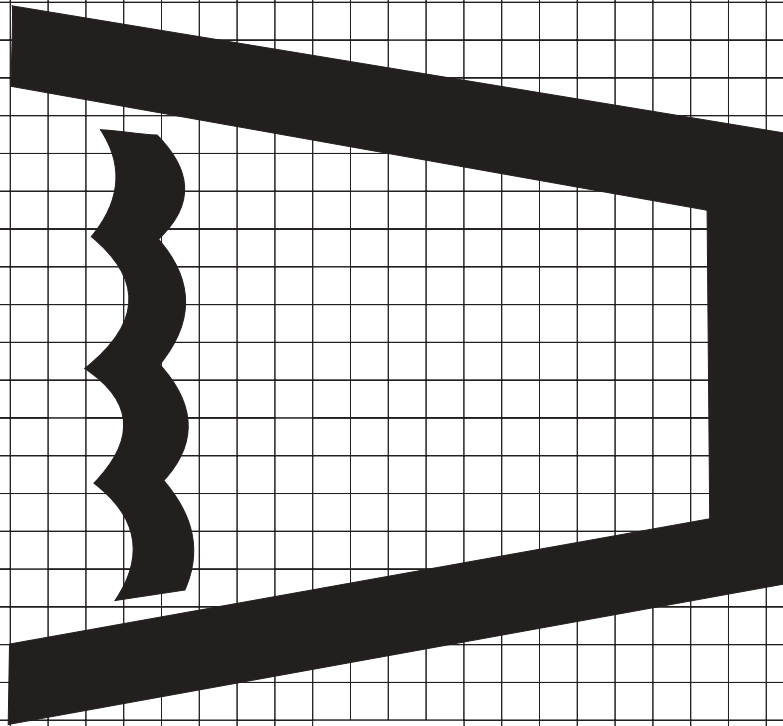

RG-050

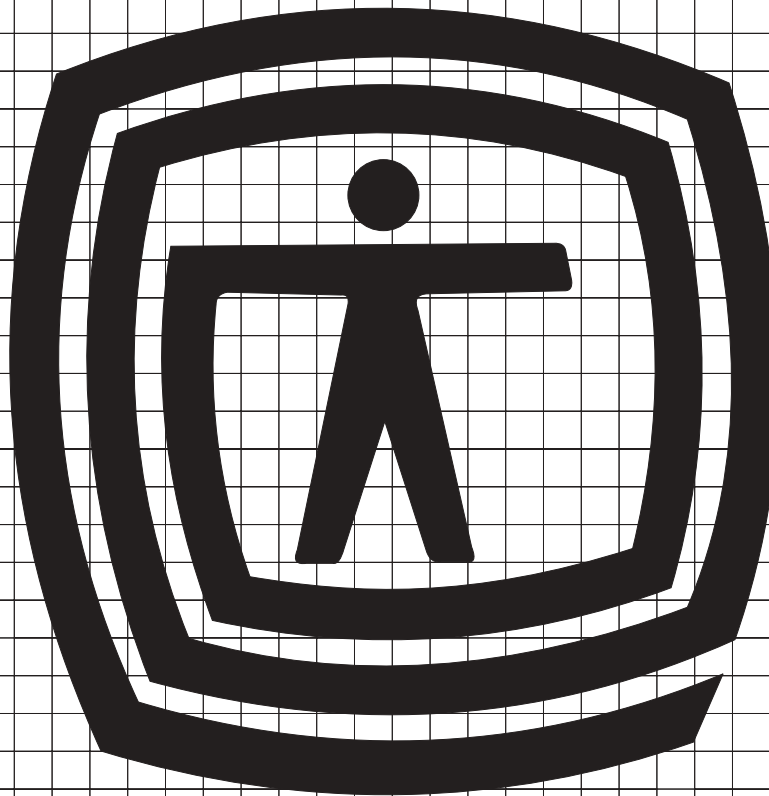

RG-060

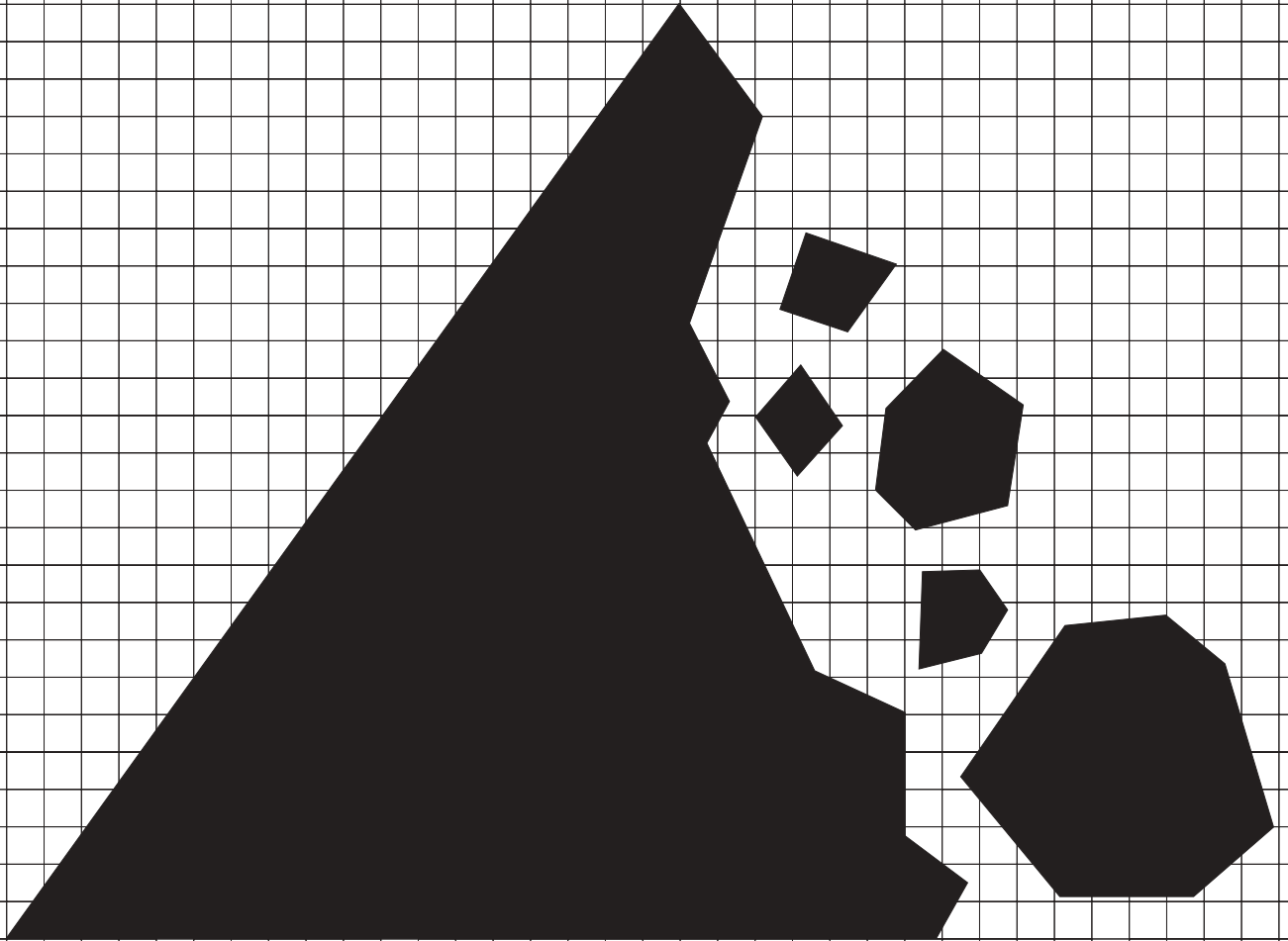

RG-070

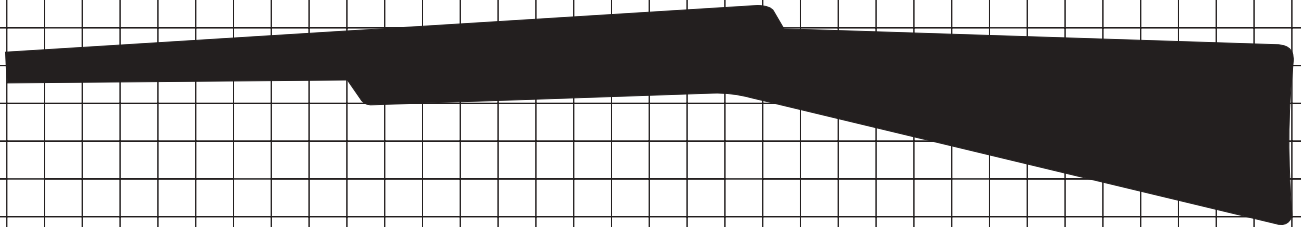

RG-080

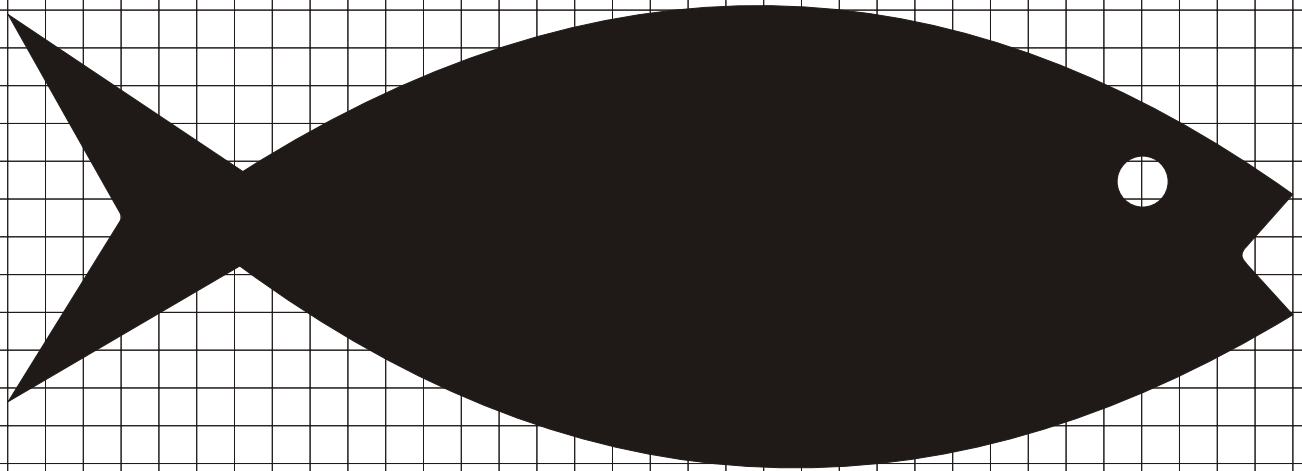

RG-090

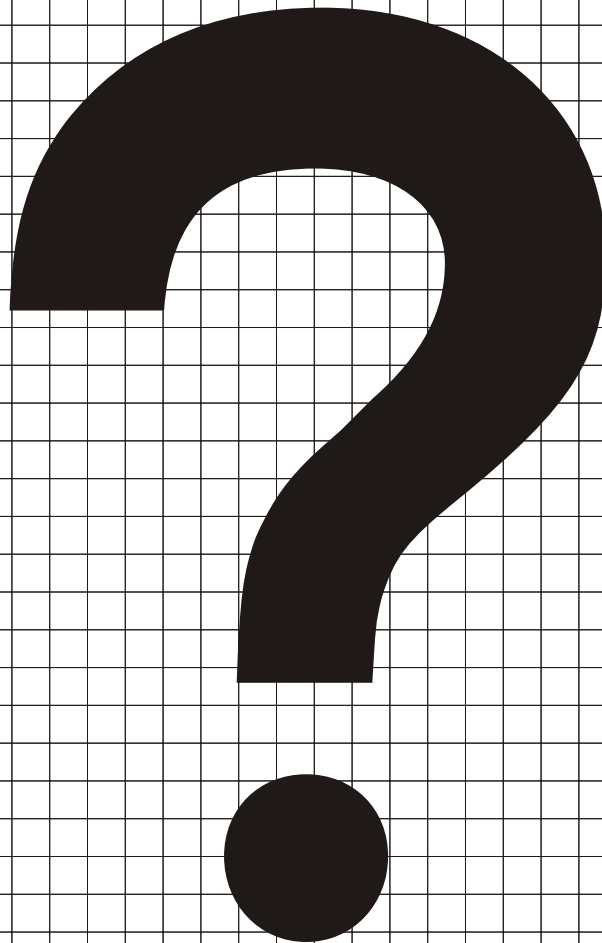

RG-100

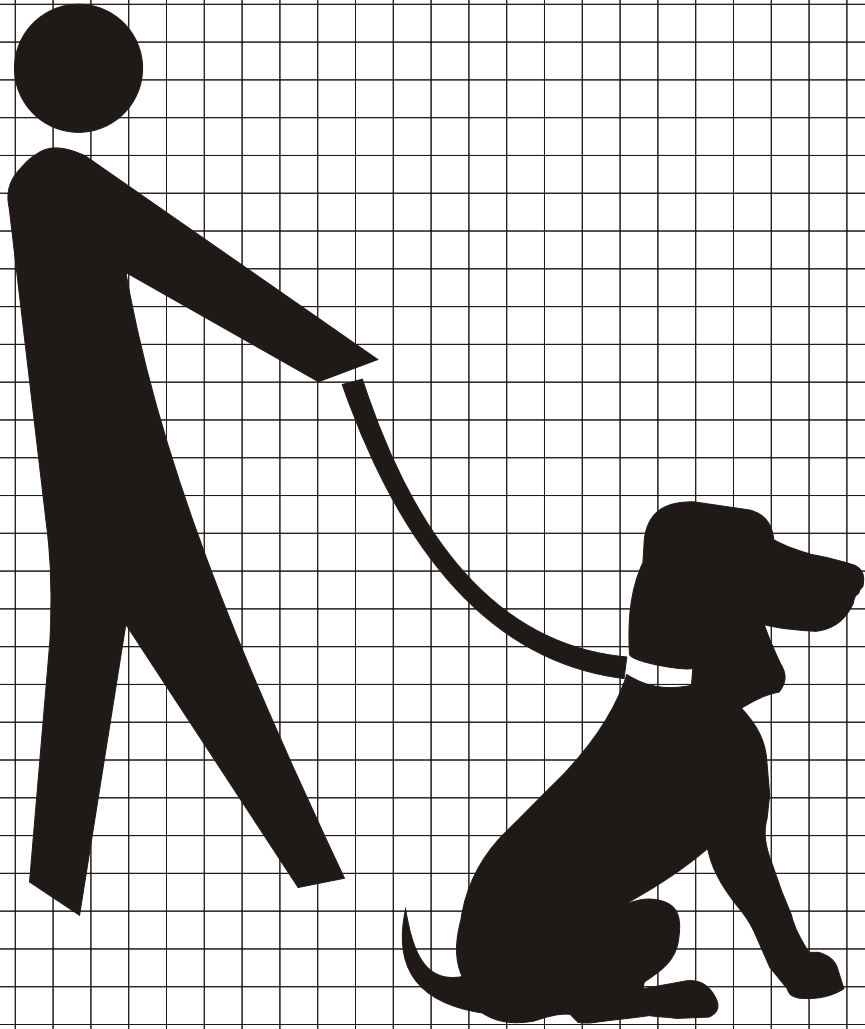

RG-110

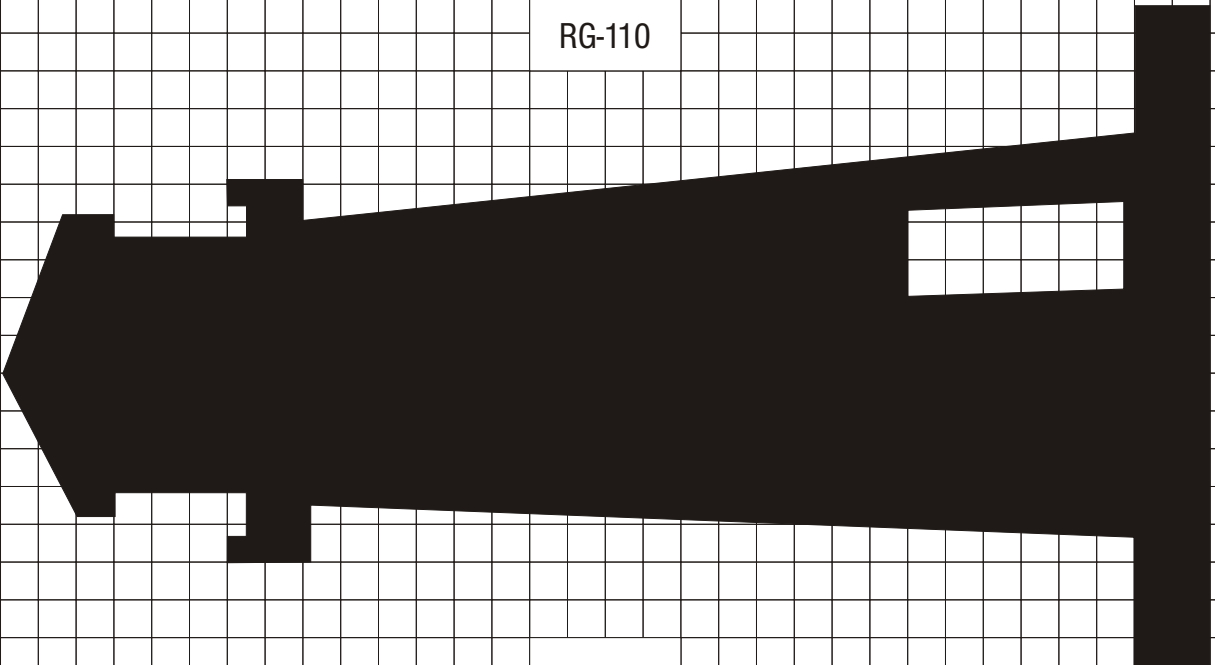

RG-120

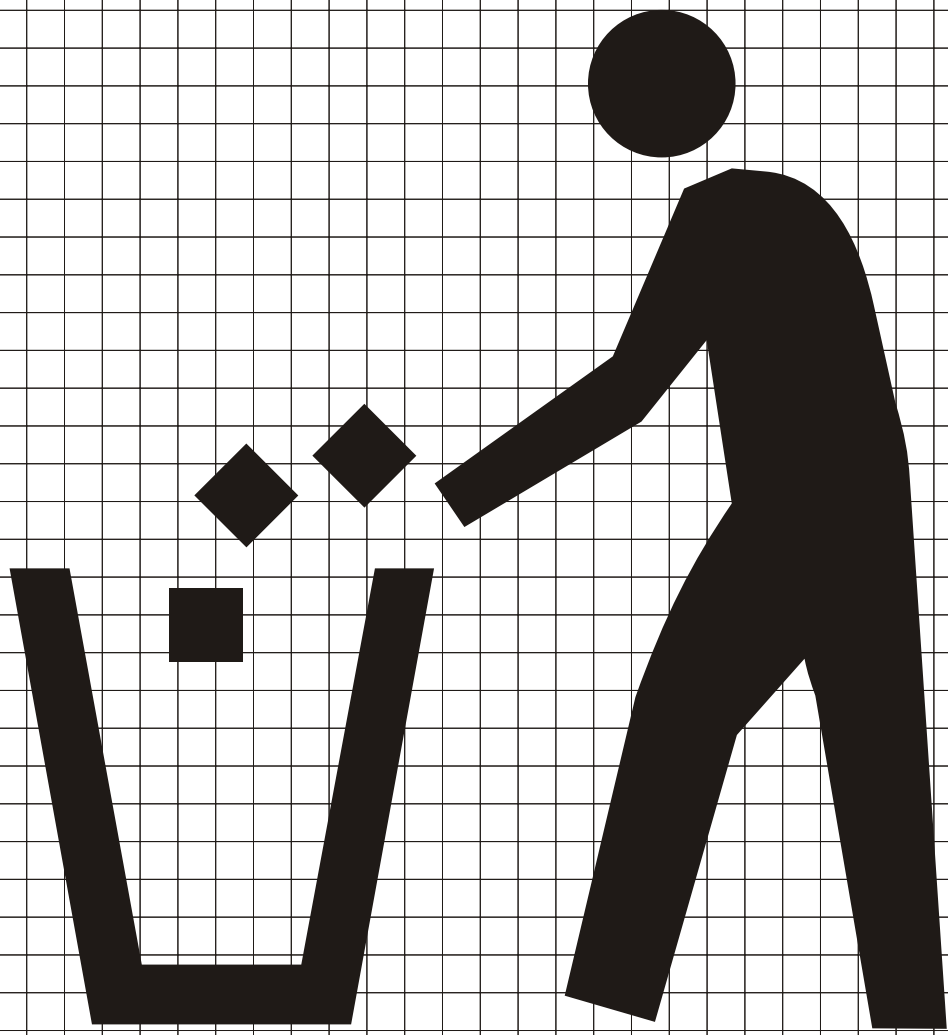

RG-130

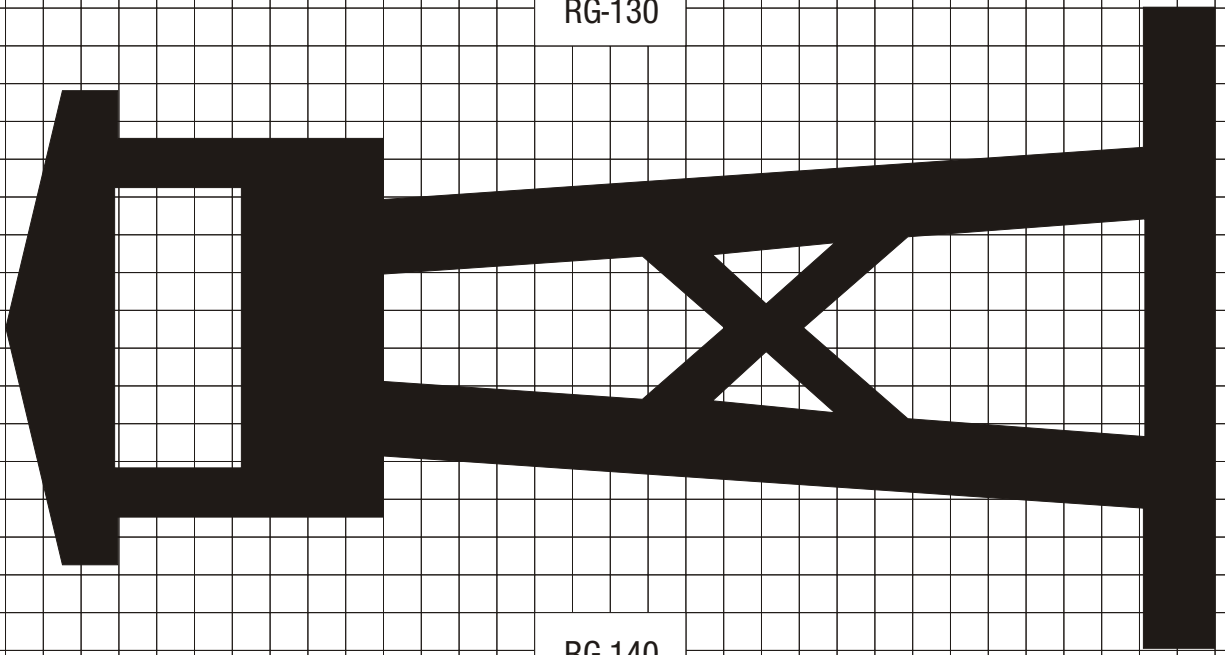

RG-140

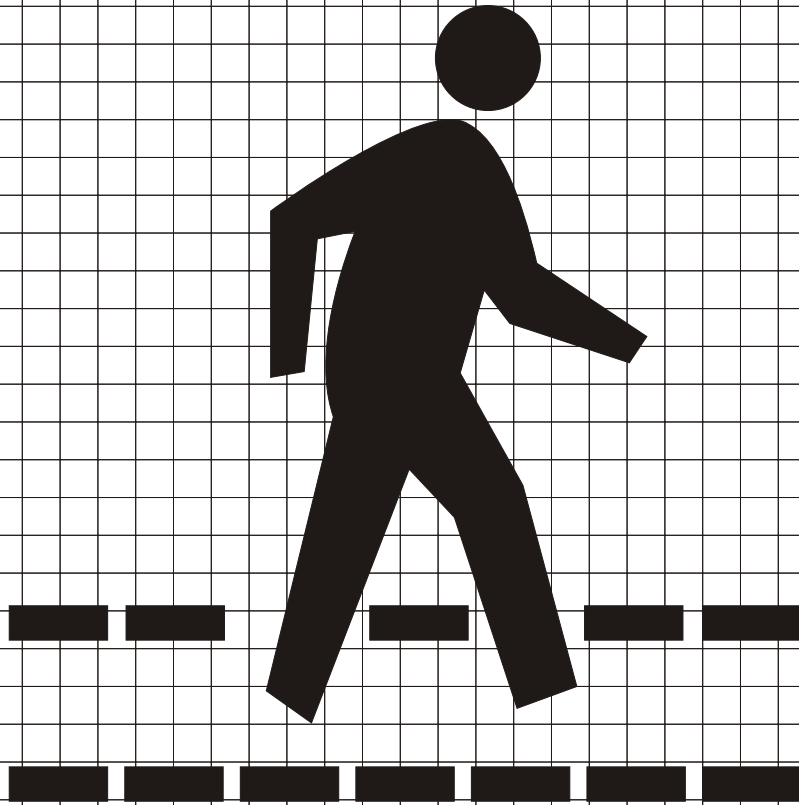

RG-150

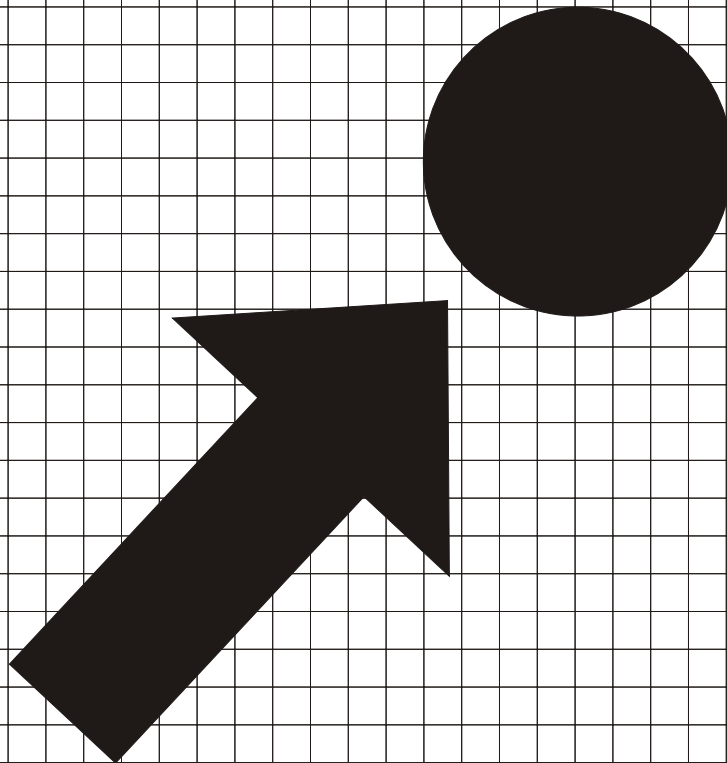

RG-160

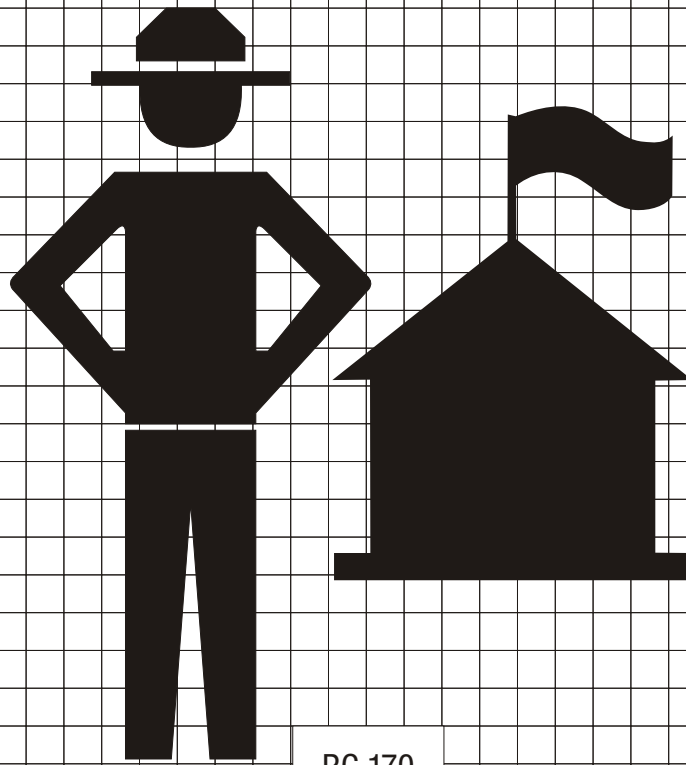

RG-170

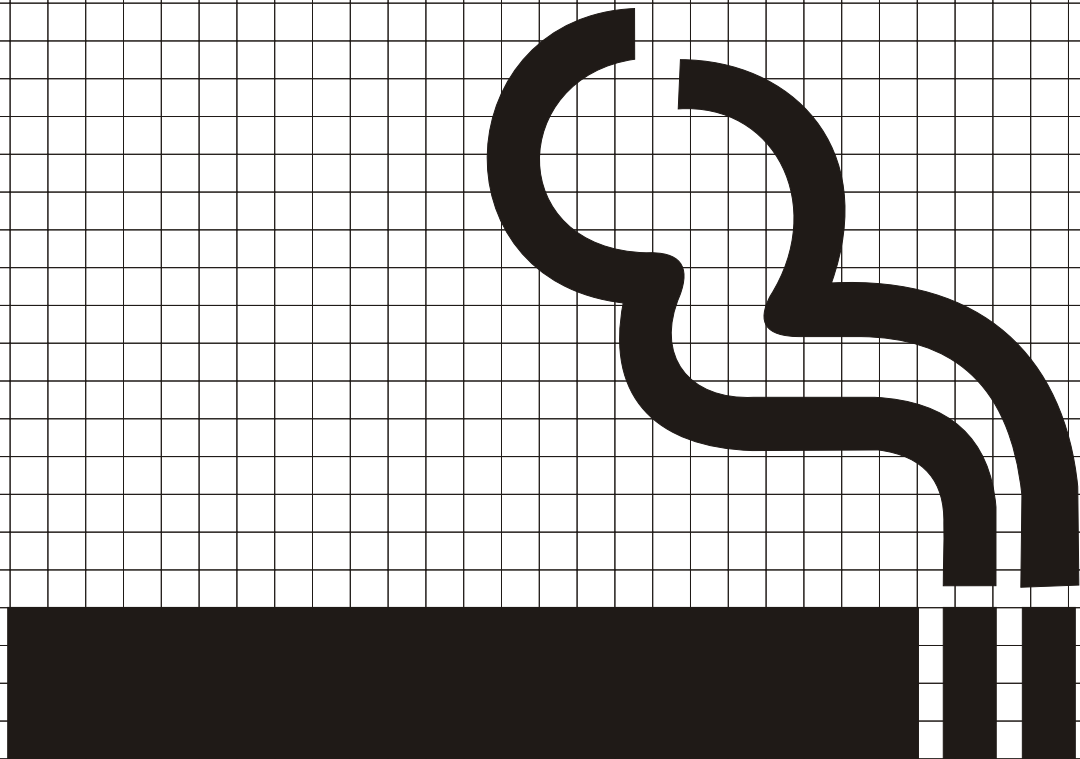

RG-180

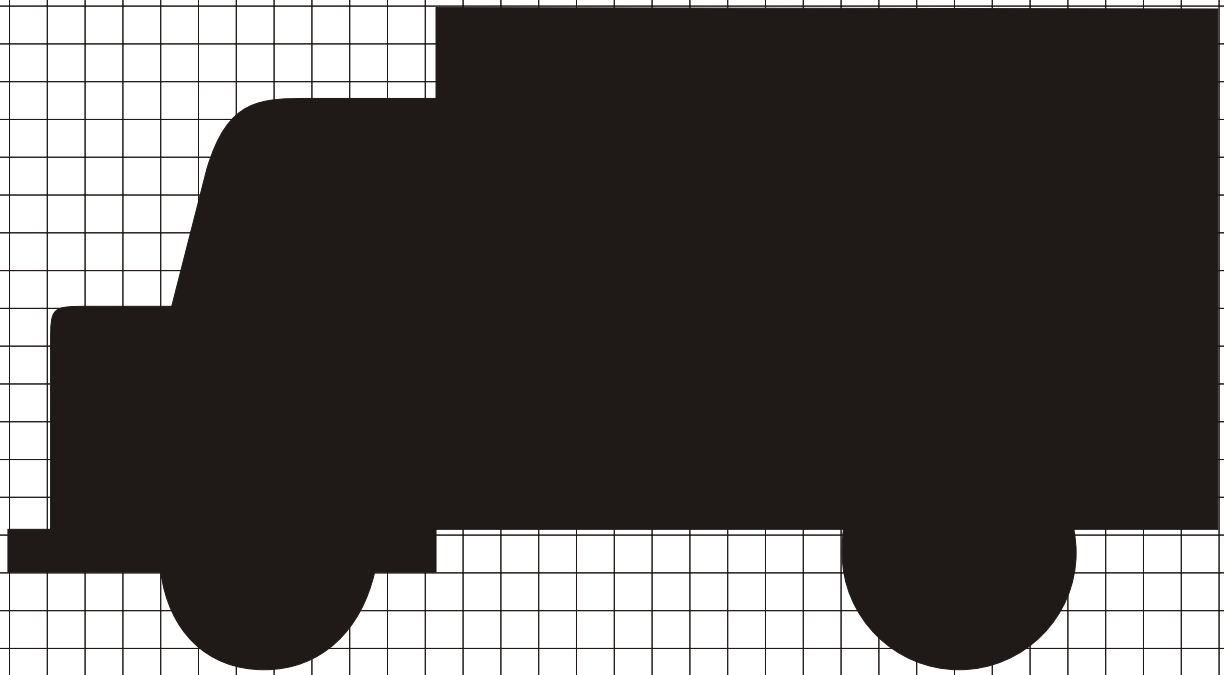

RG-190

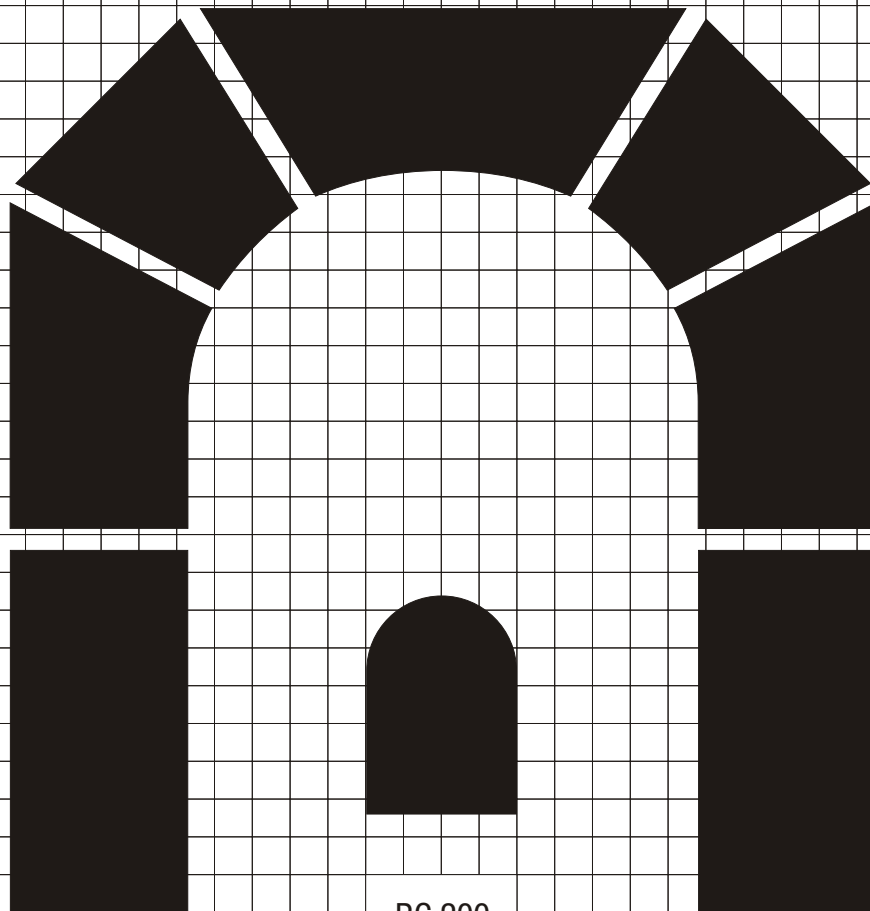

RG-200

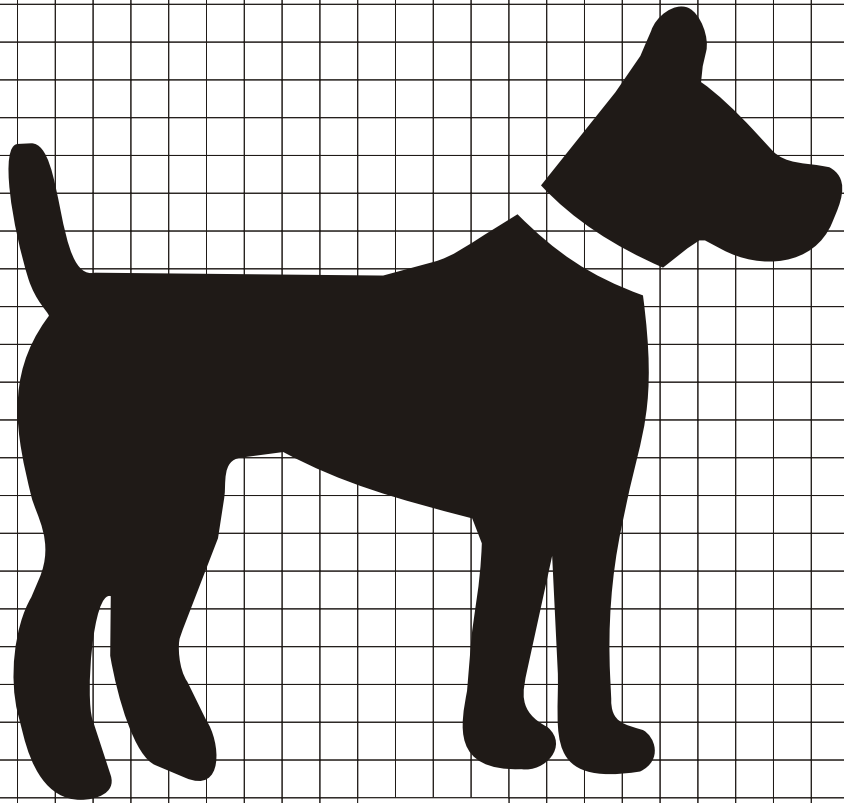

RG-240

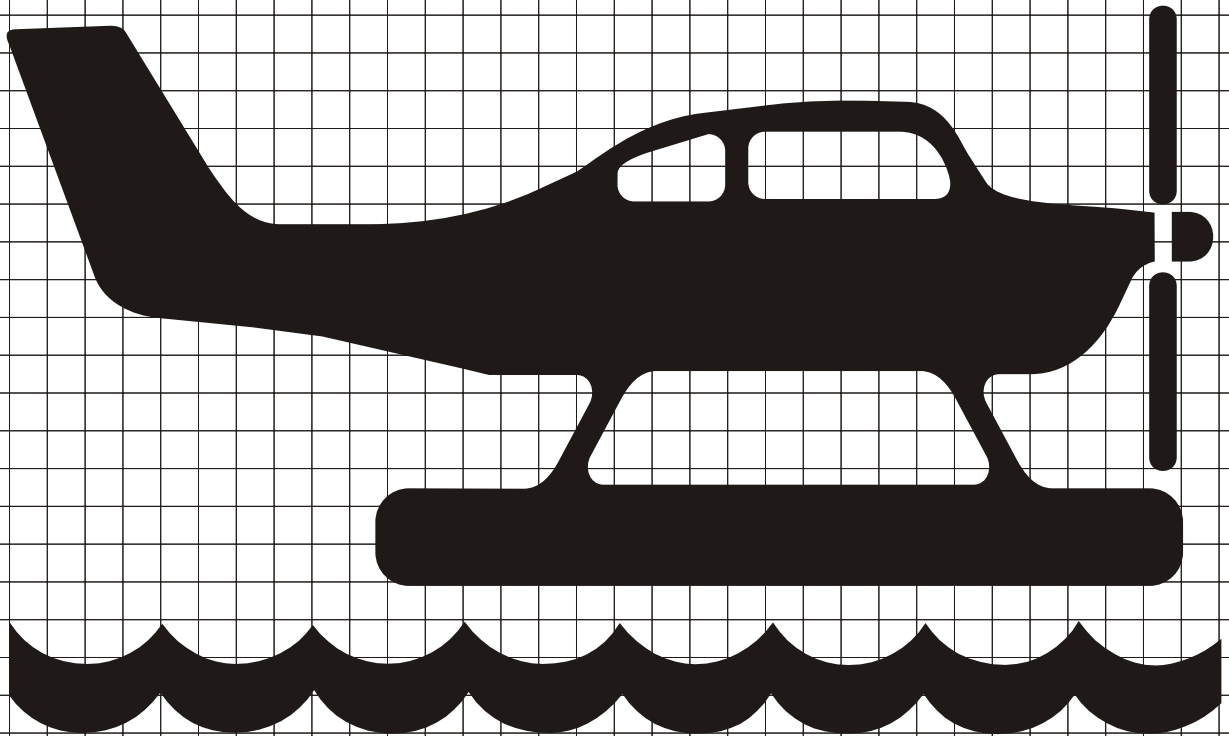

RG-260

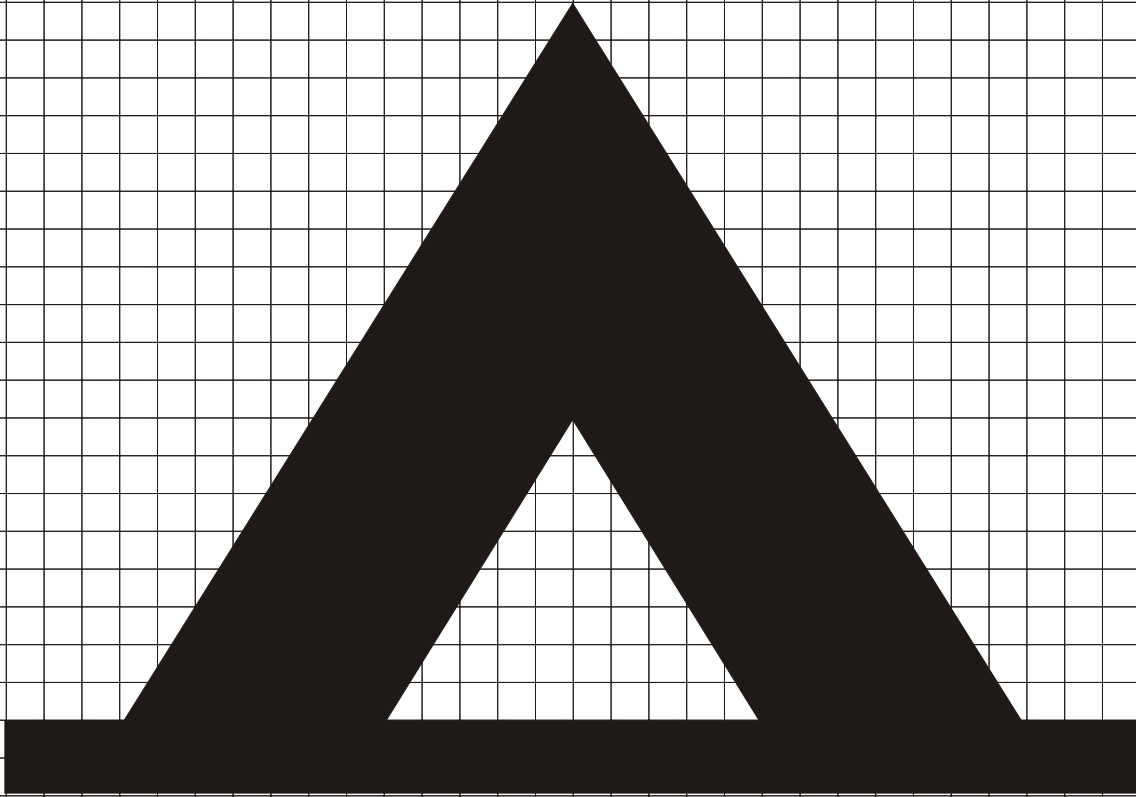

RM-010

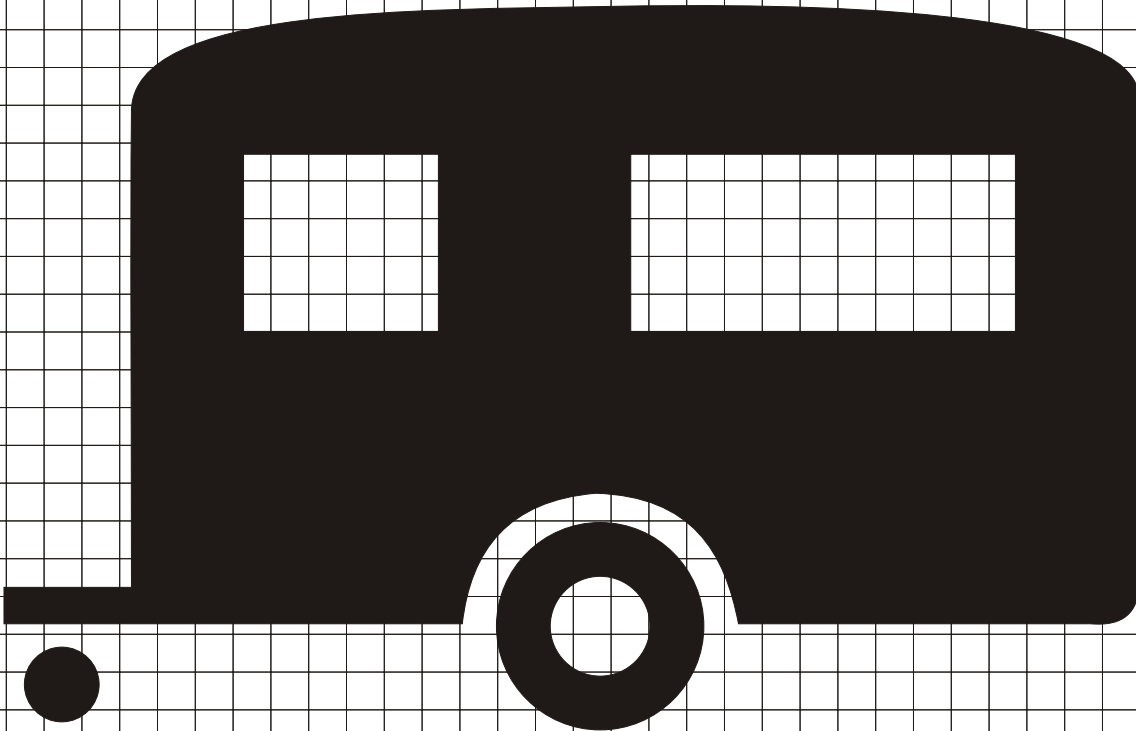

RM-020

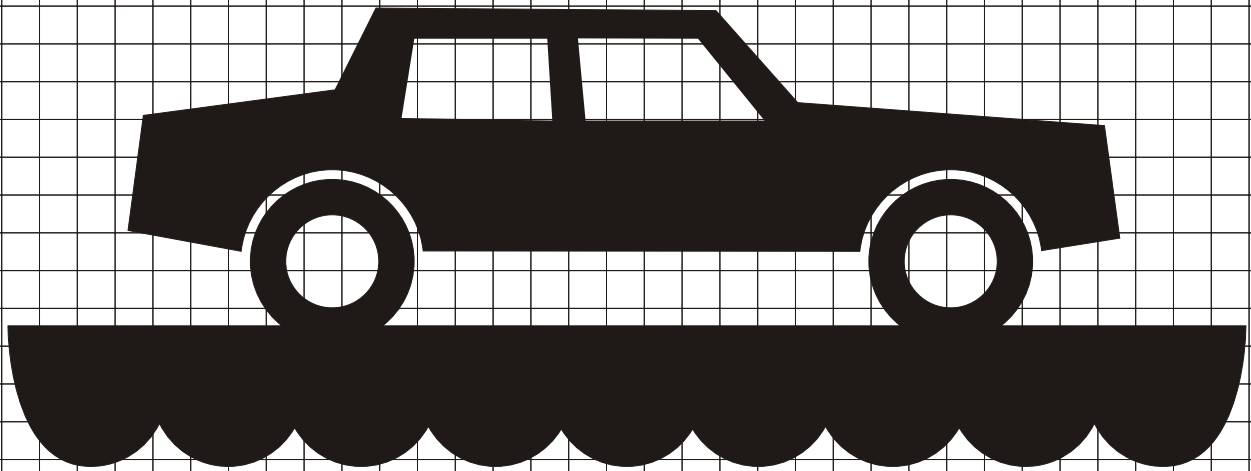

RM-030

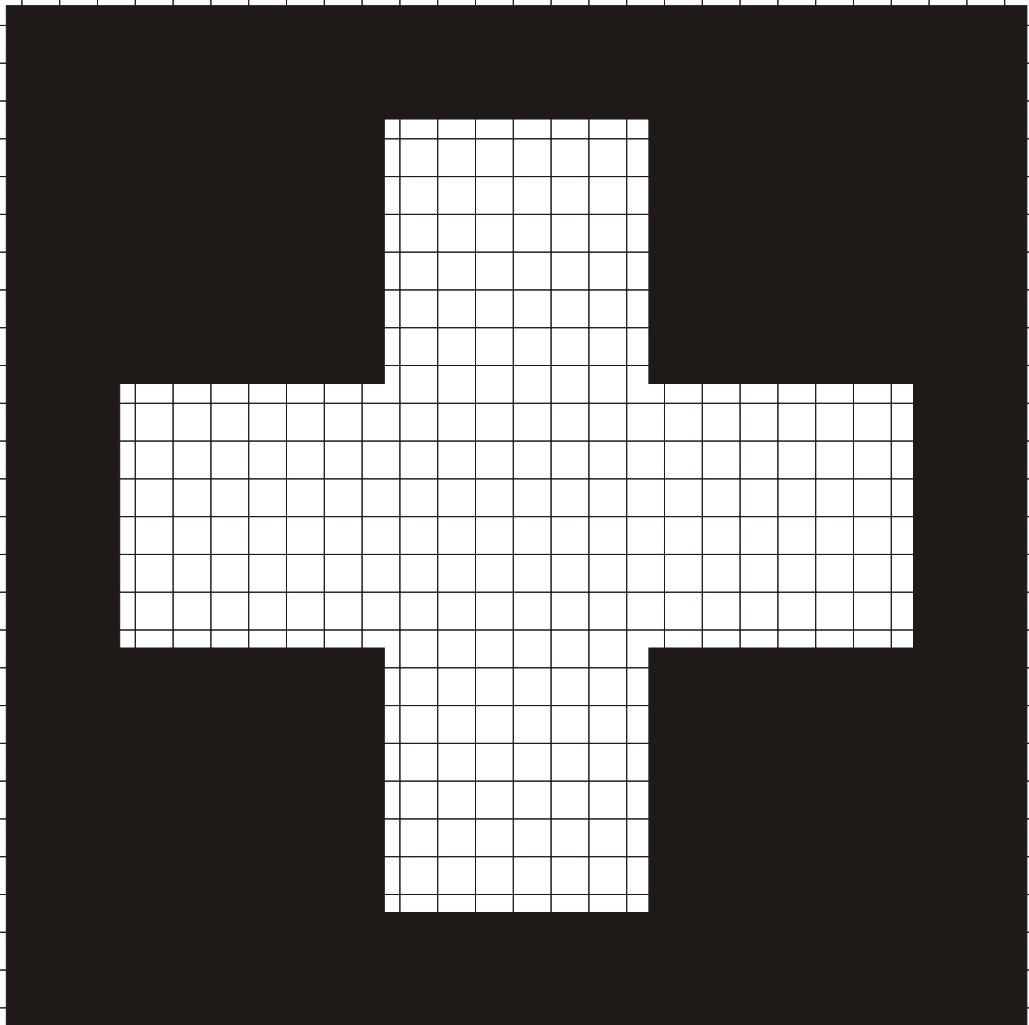

RM-040

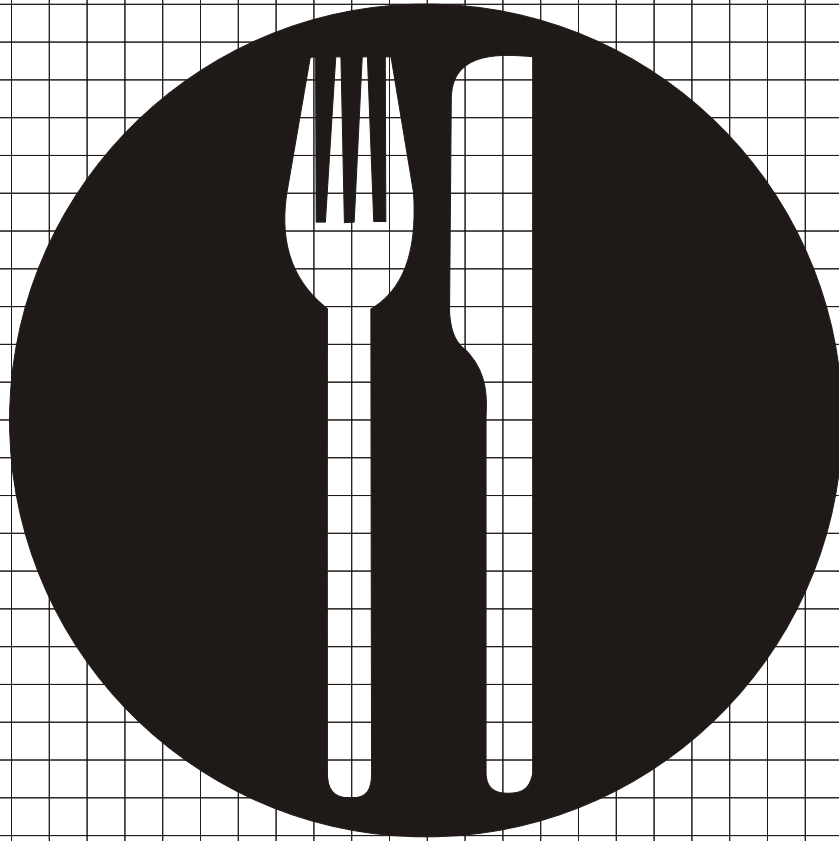

RM-050

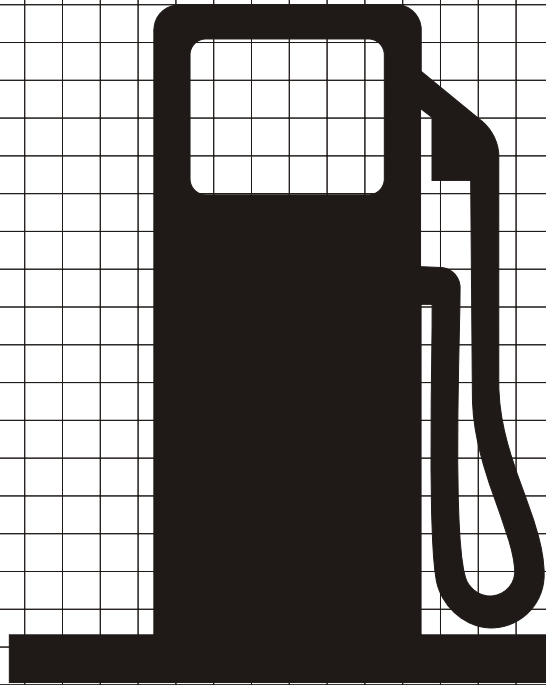

RM-060

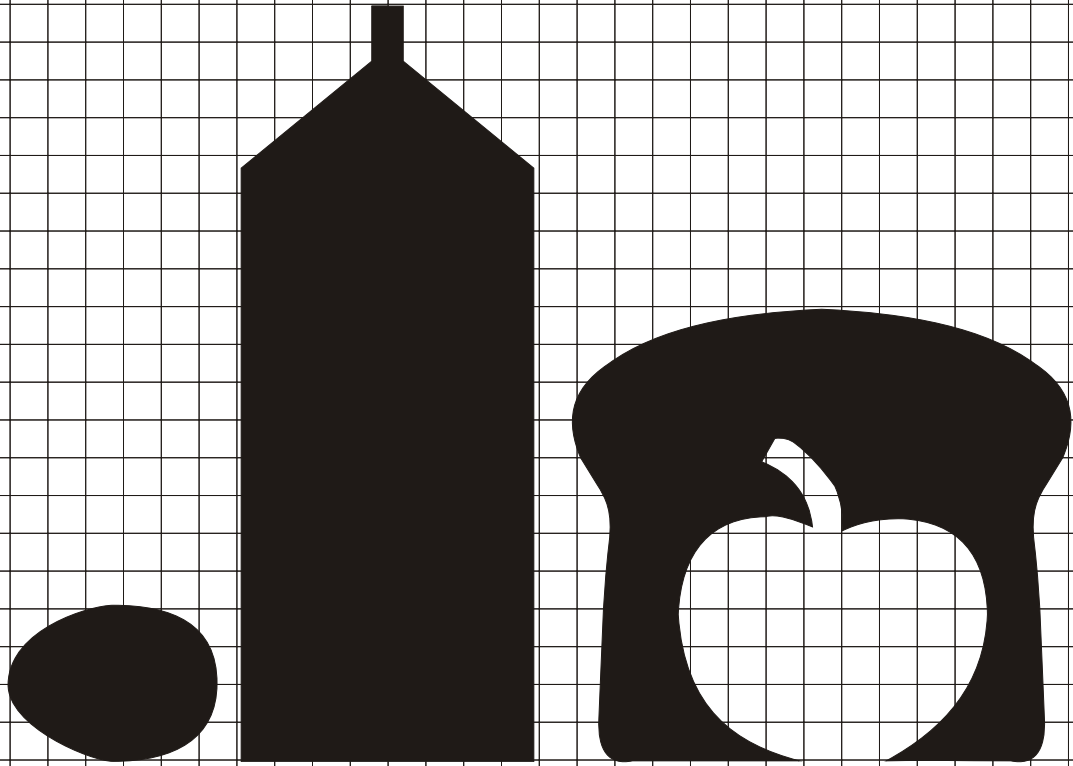

RM-070

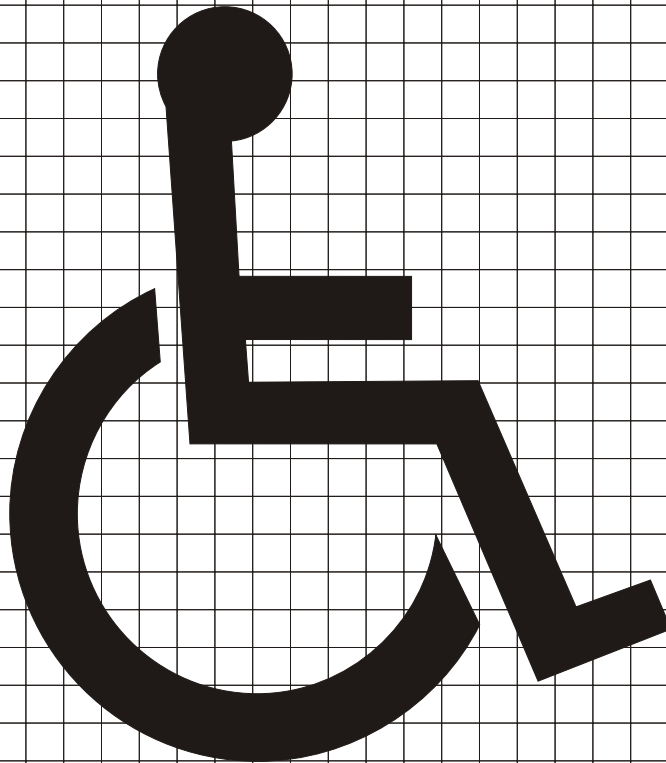

RM-080

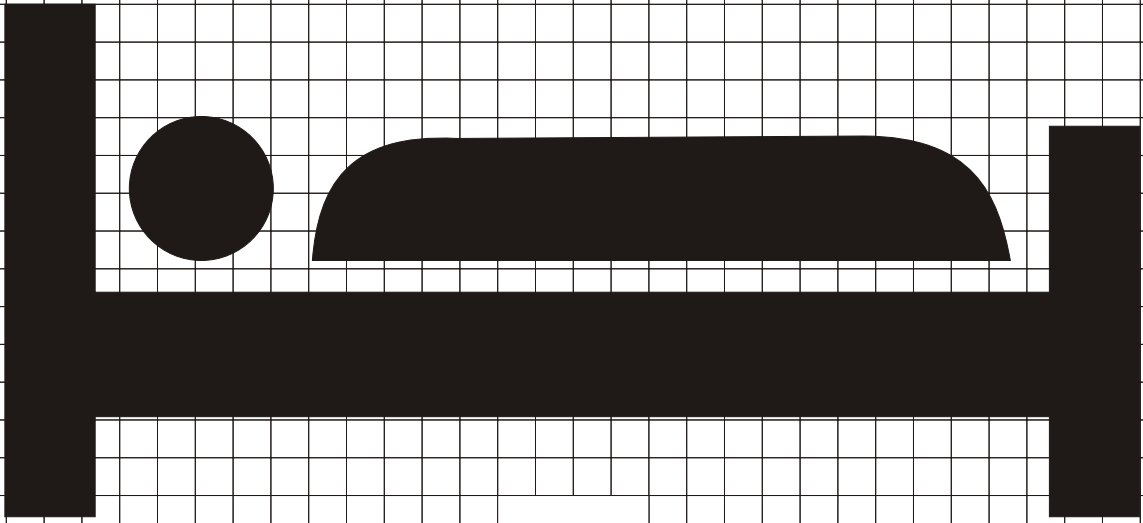

RM-090

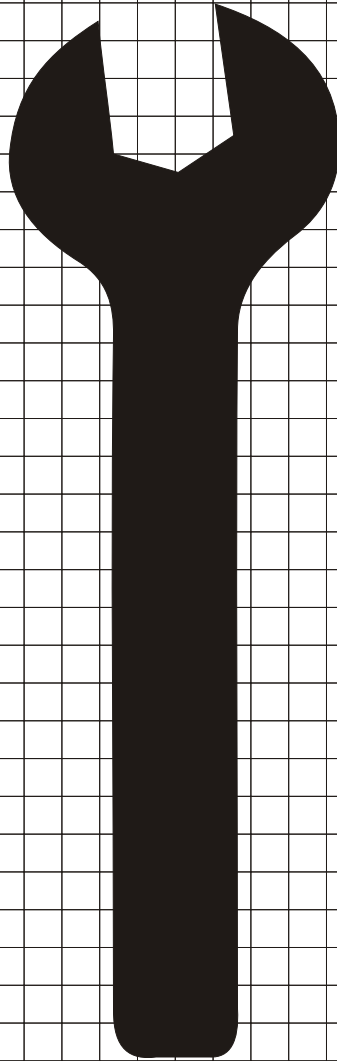

RM-100

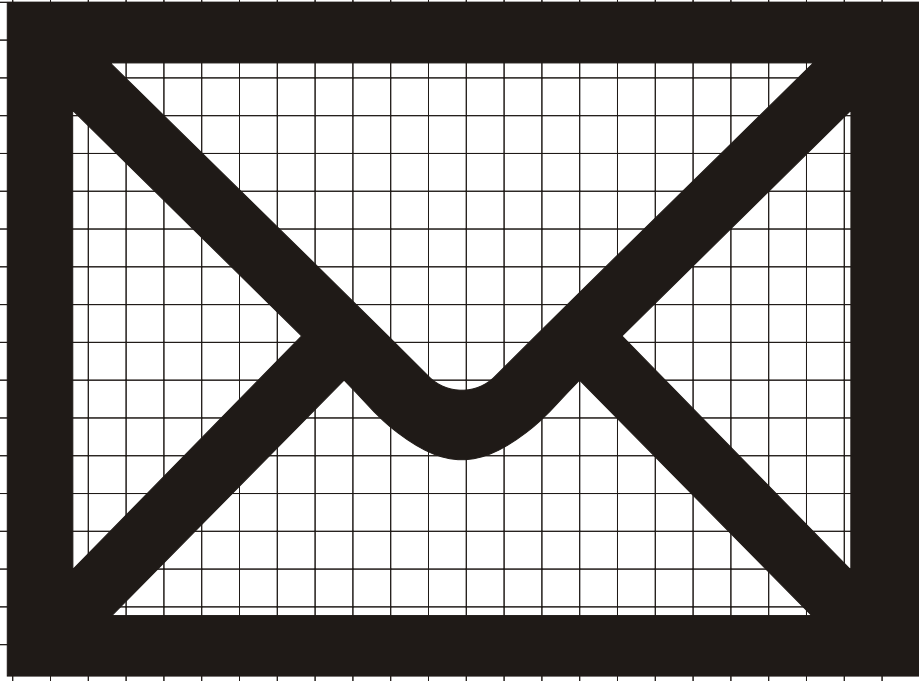

RM-110

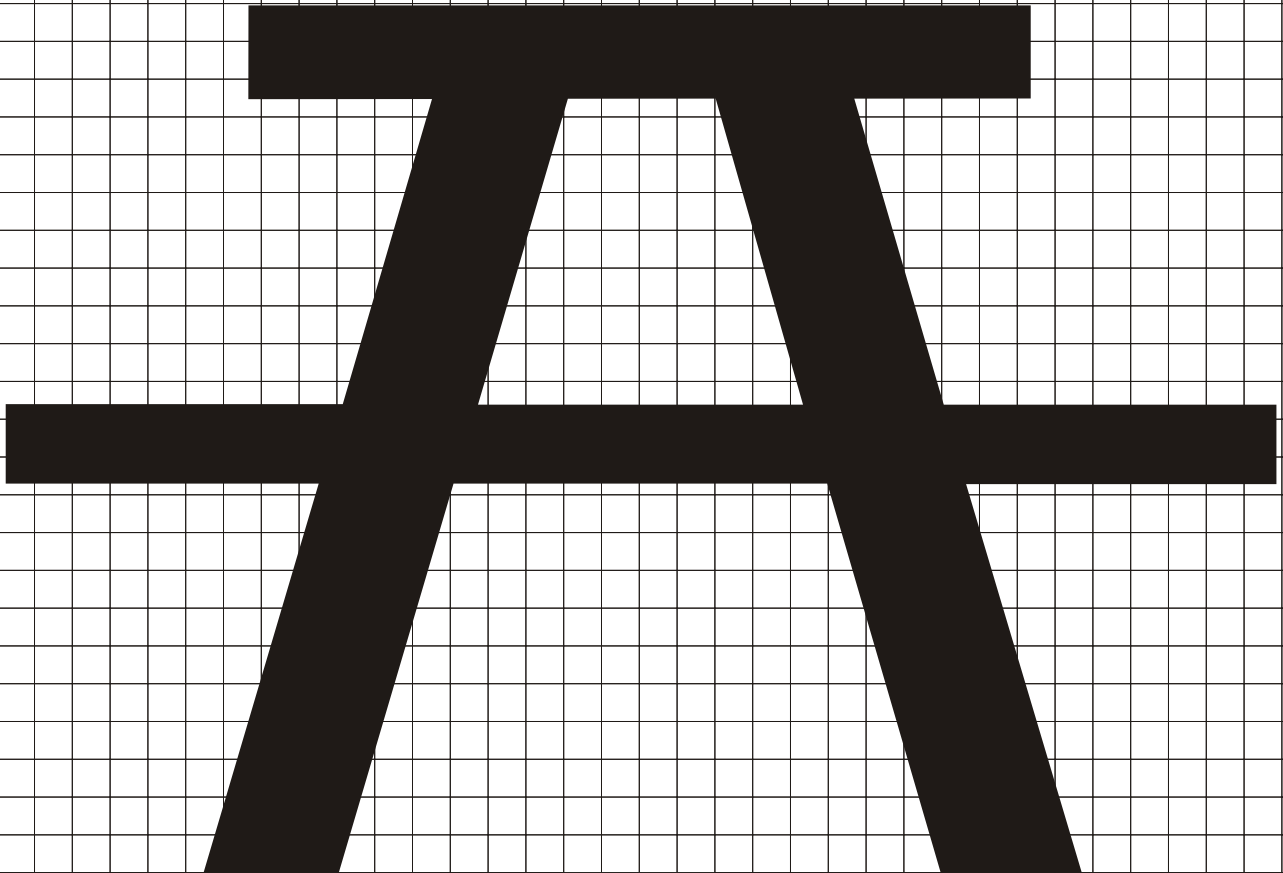

RM-120

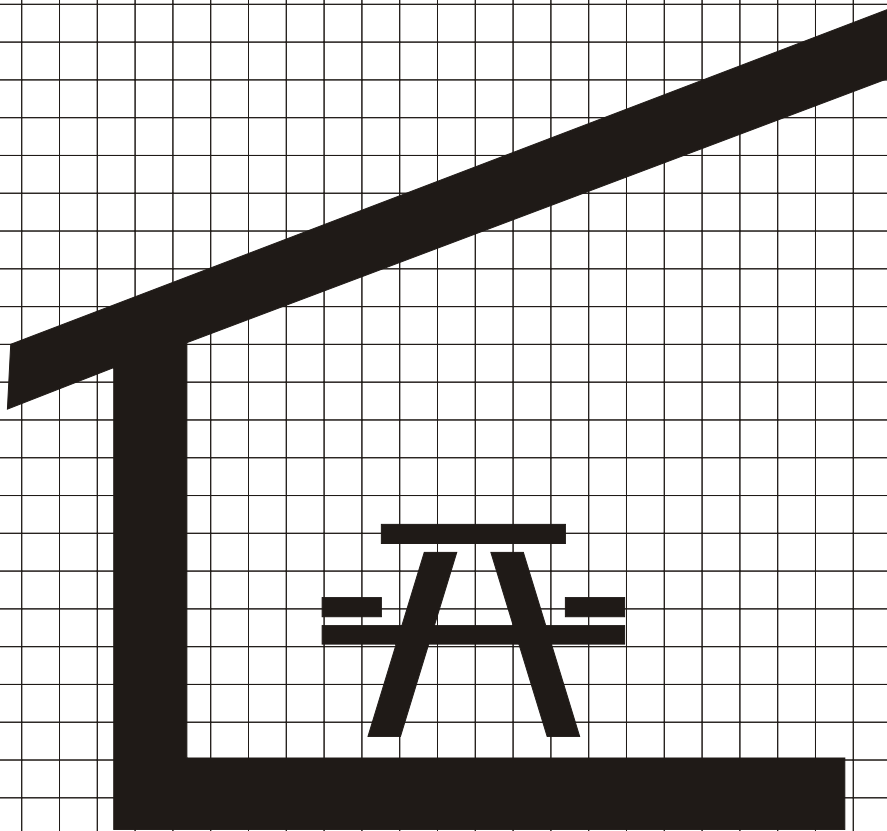

RM-130

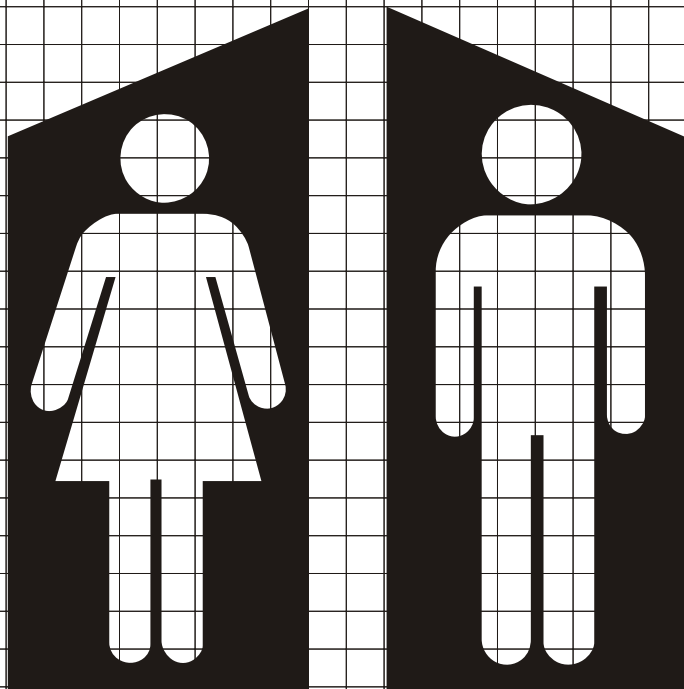

RM-140

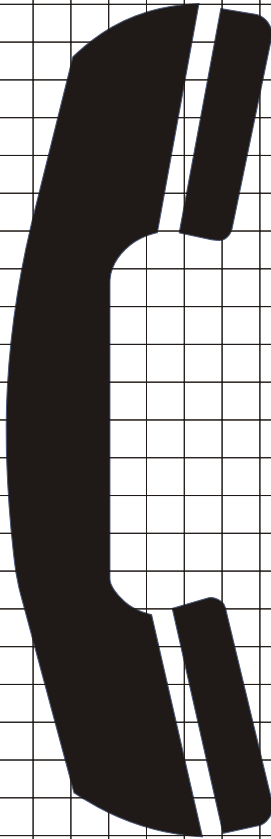

RM-150

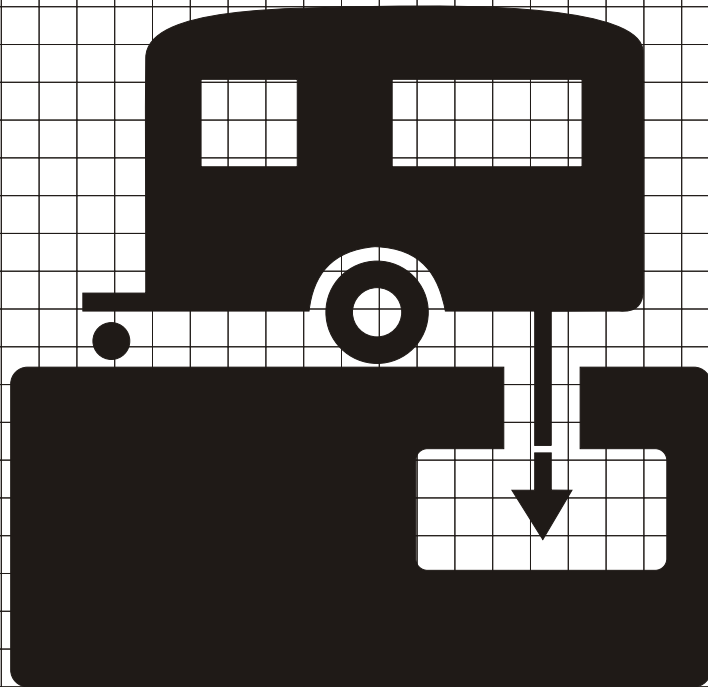

RM-160

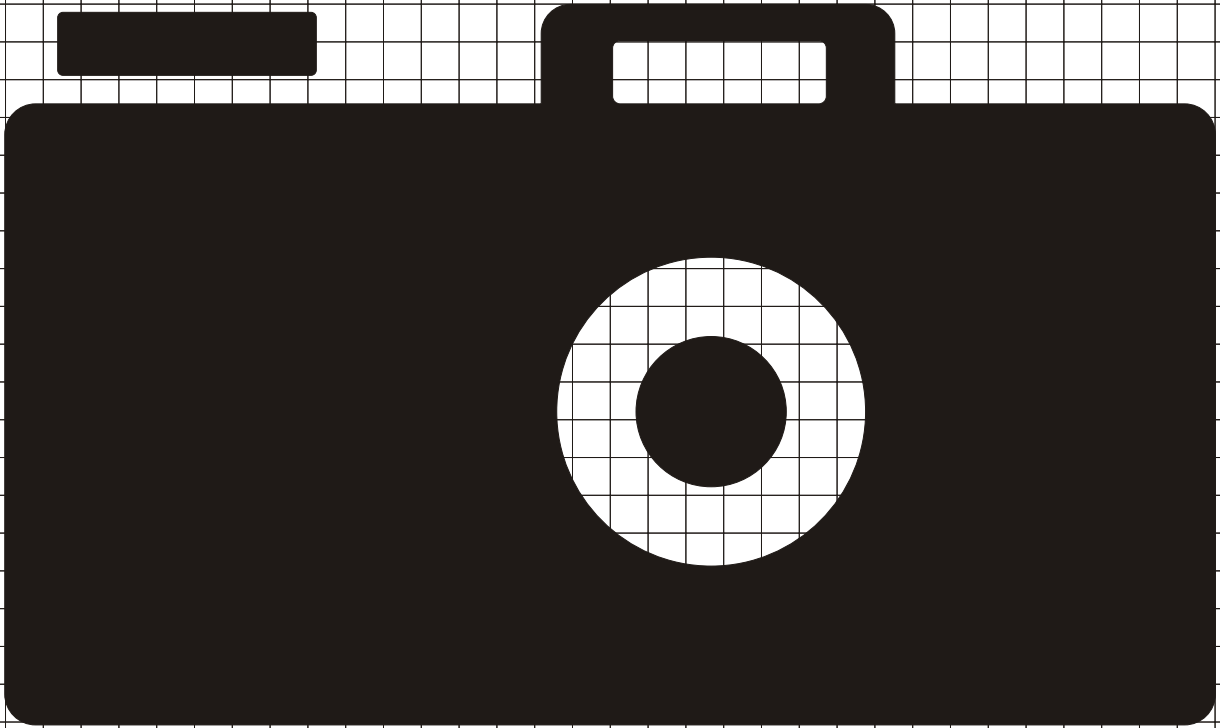

RM-170

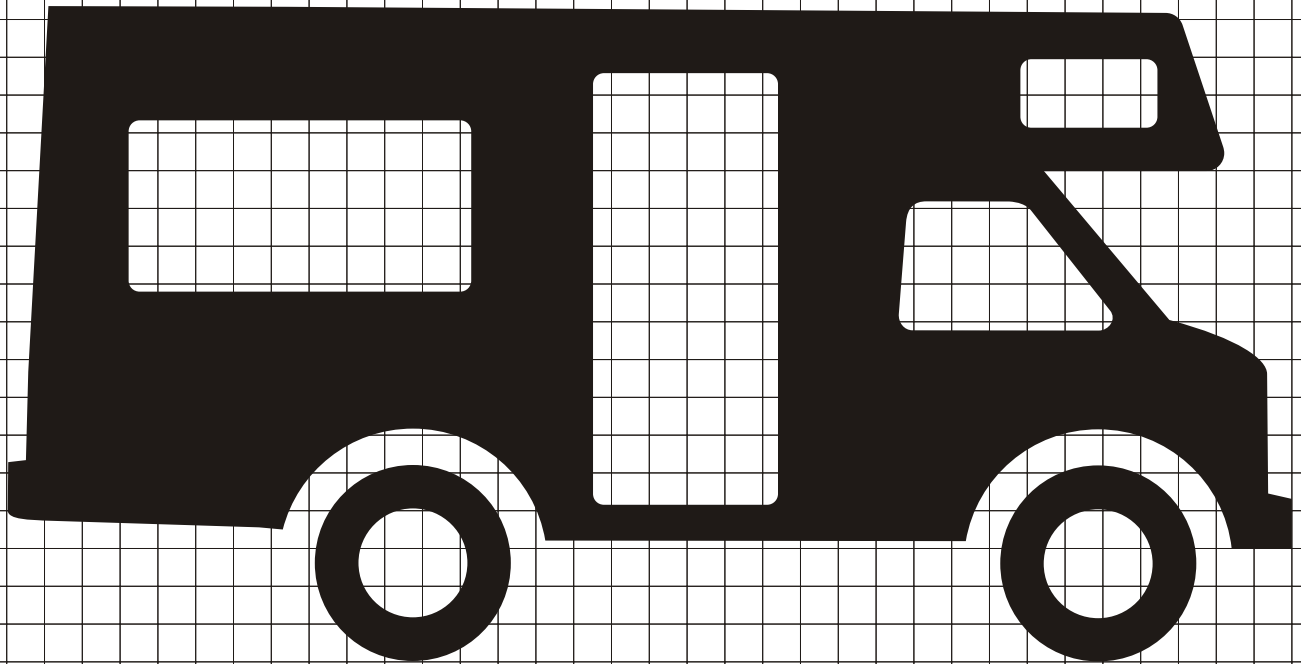

RM-200

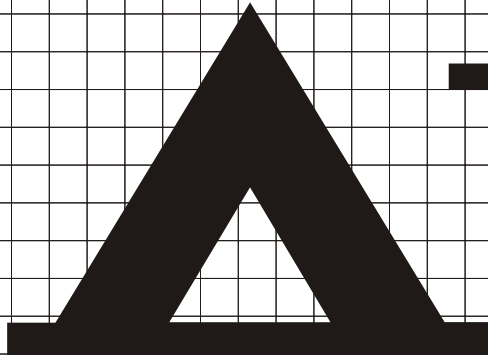
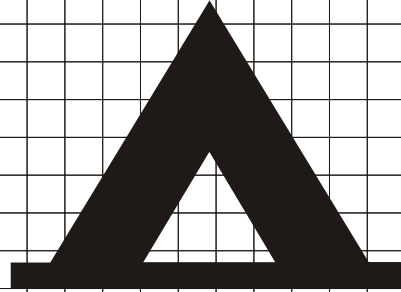
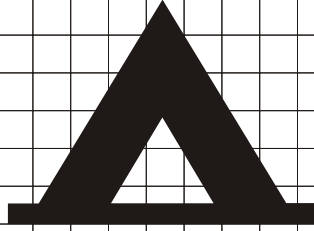

RM-210

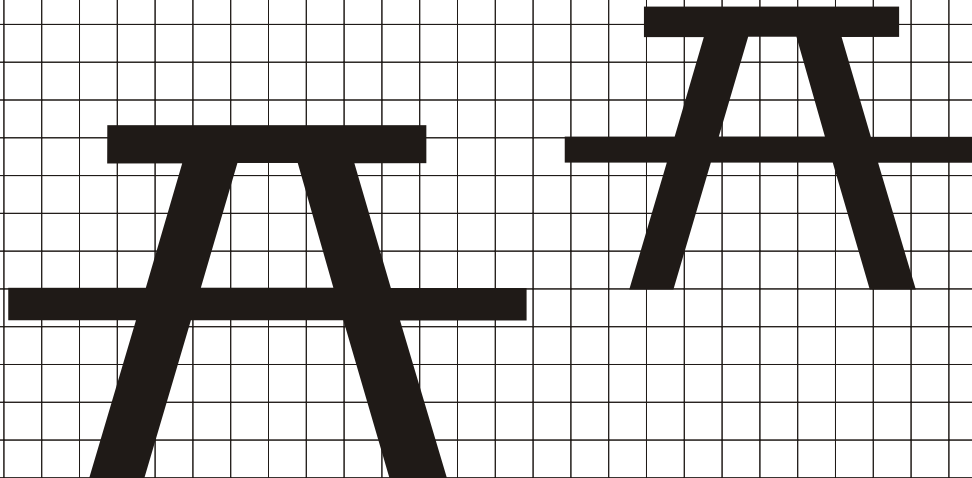
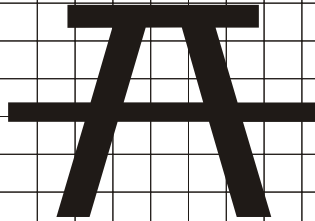

RM-220

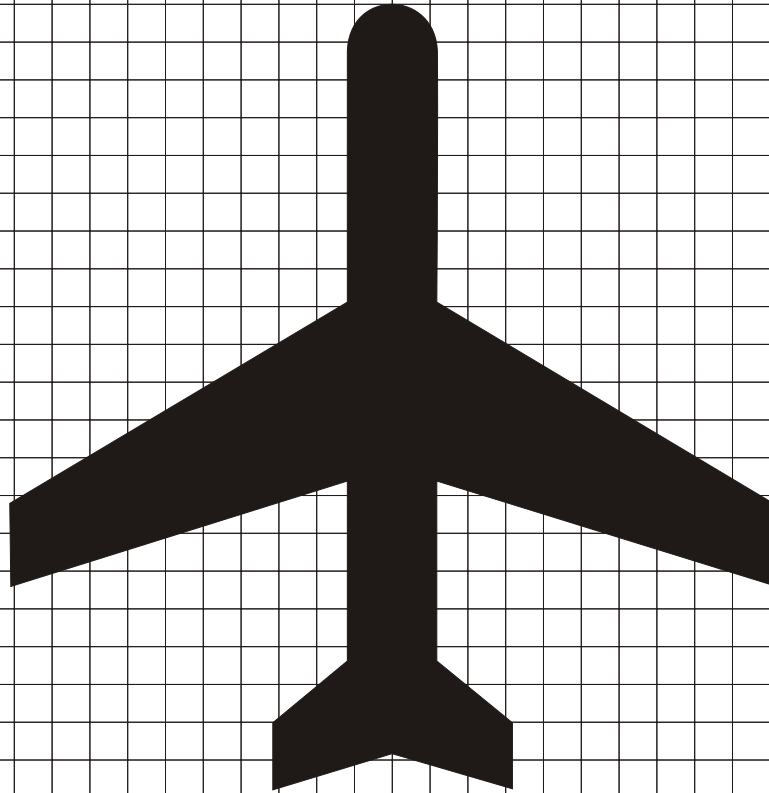

RA-010

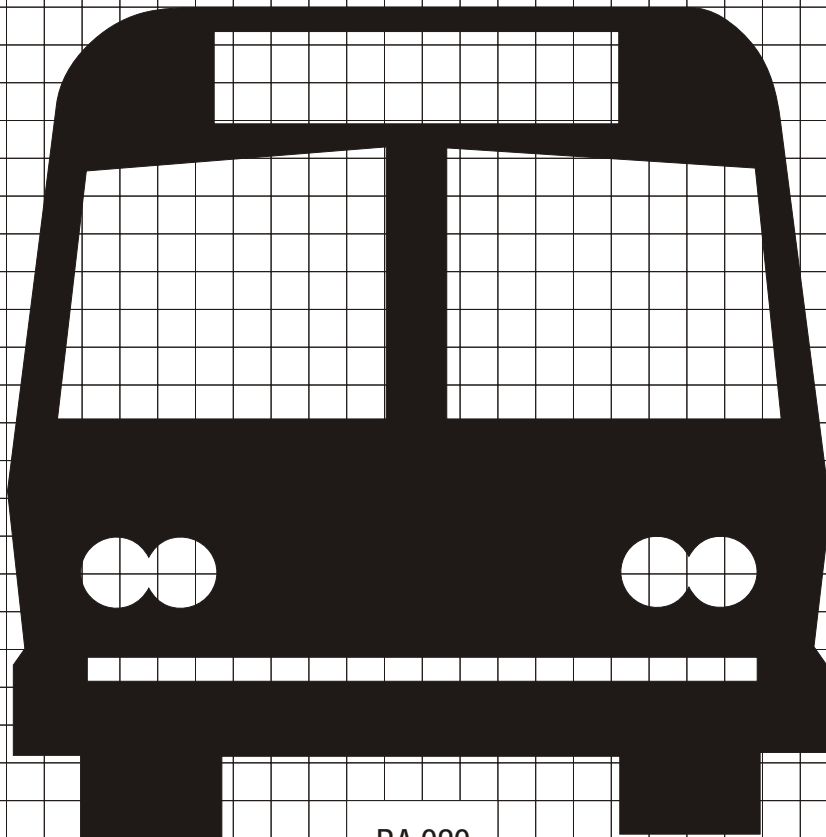

RA-020

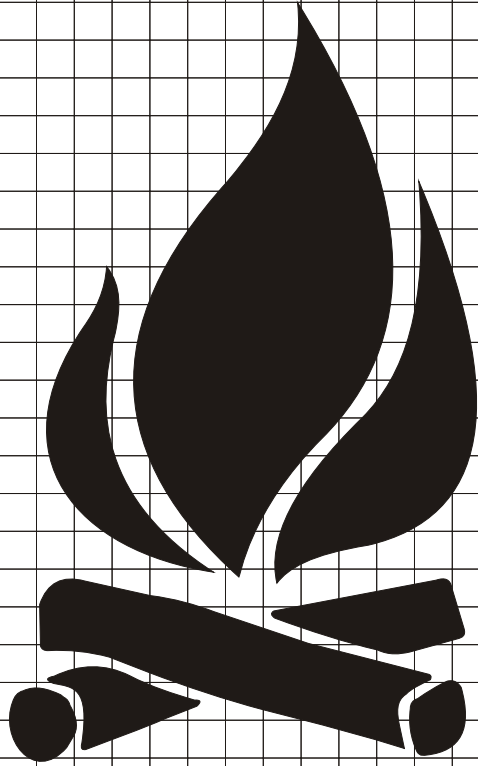

RA-030

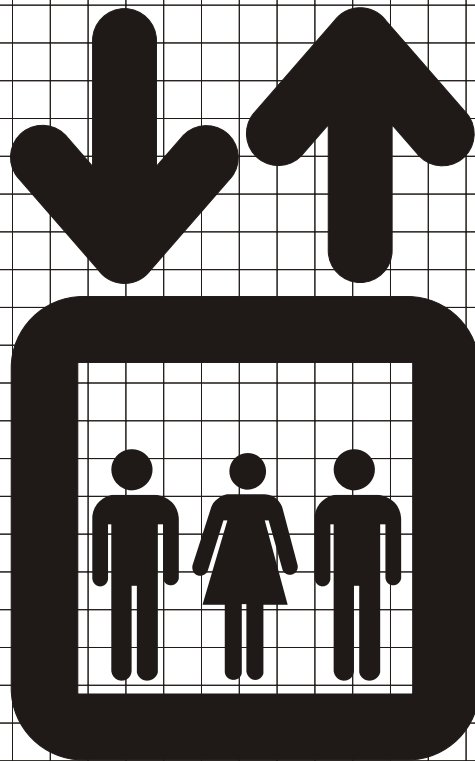

RA-040



RA-050

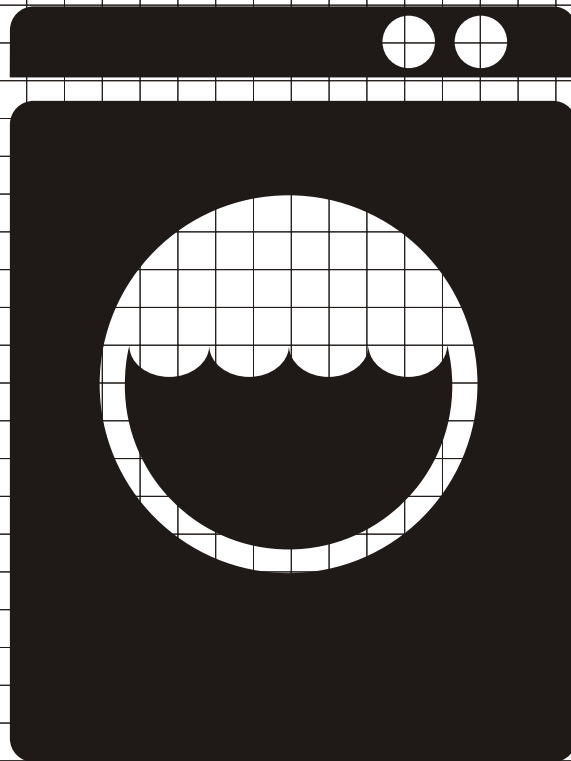

RA-060

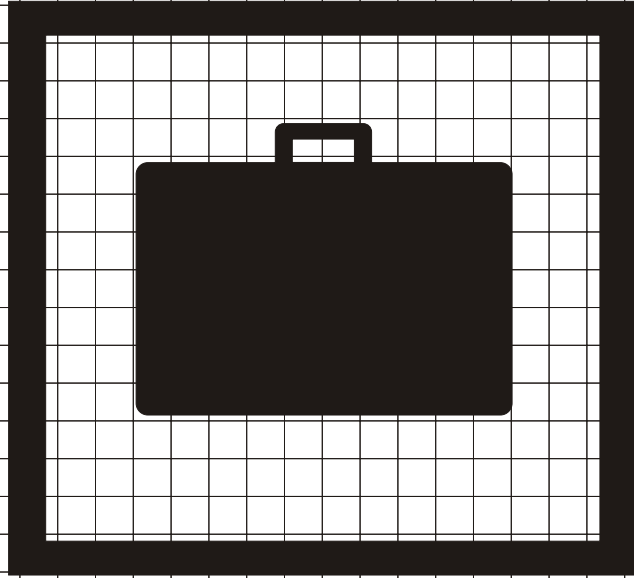
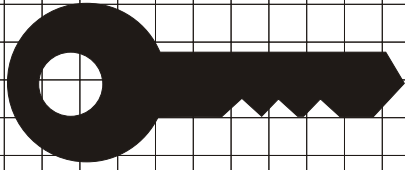

RA-070

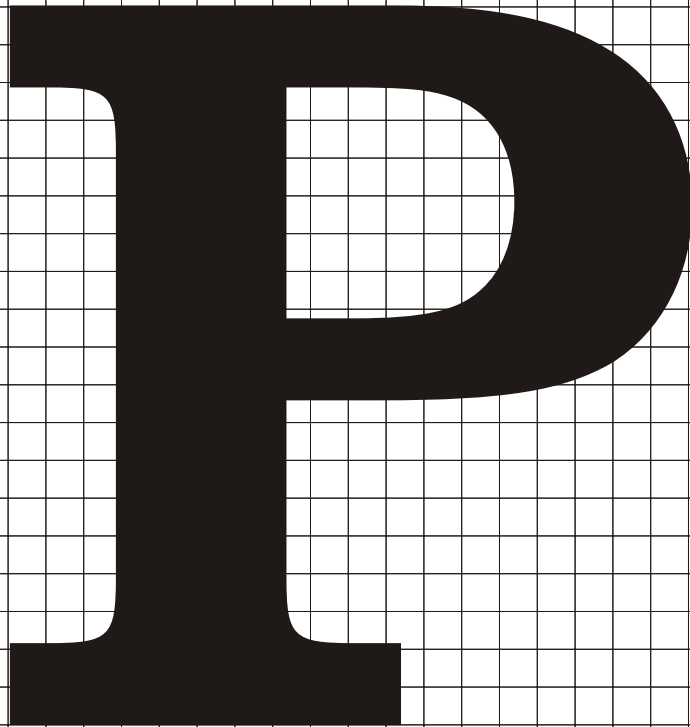

RA-080

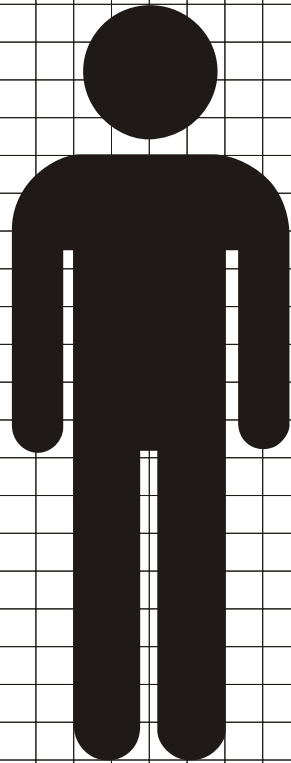

RA-090

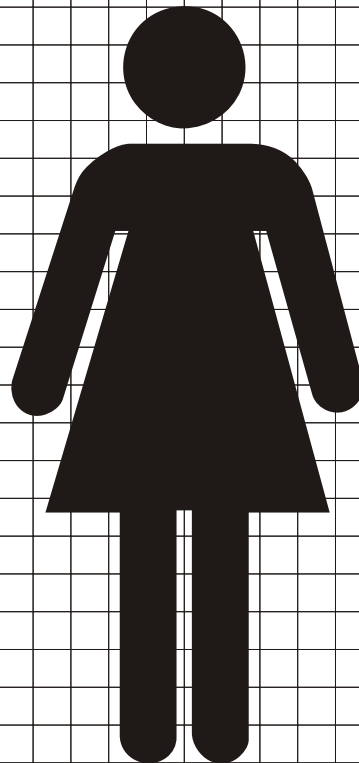

RA-100

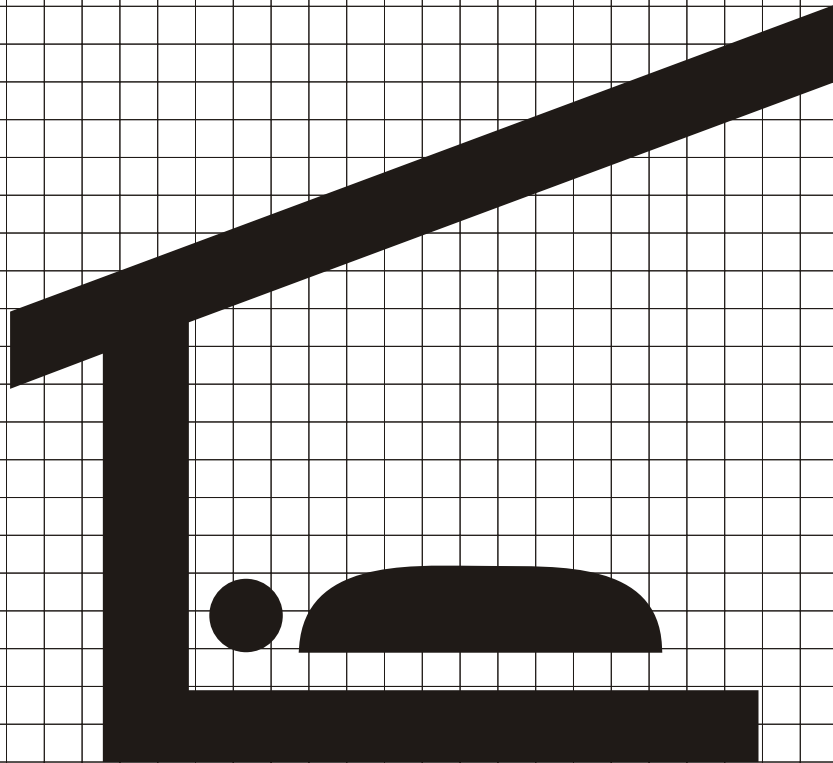

RA-110

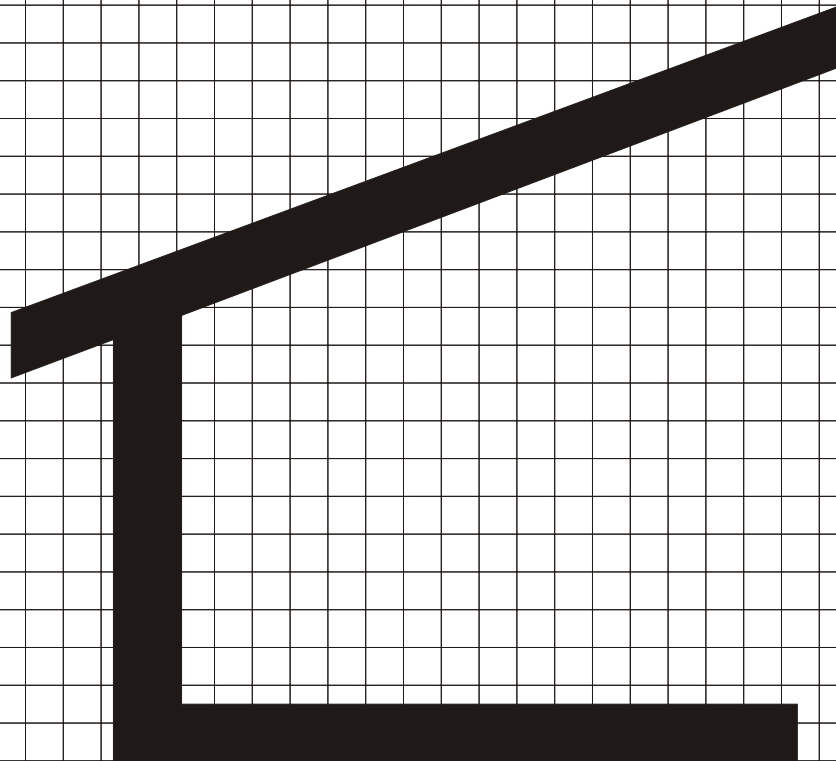

RA-120

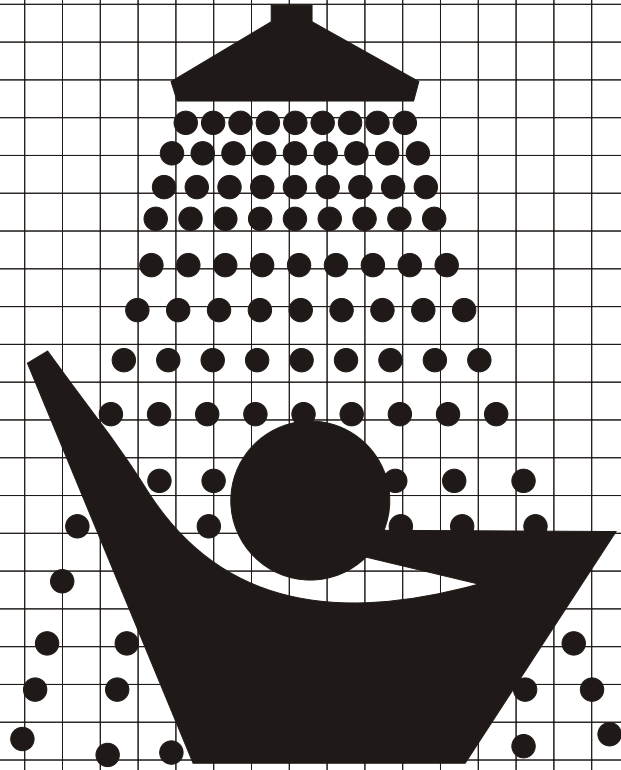

RA-130

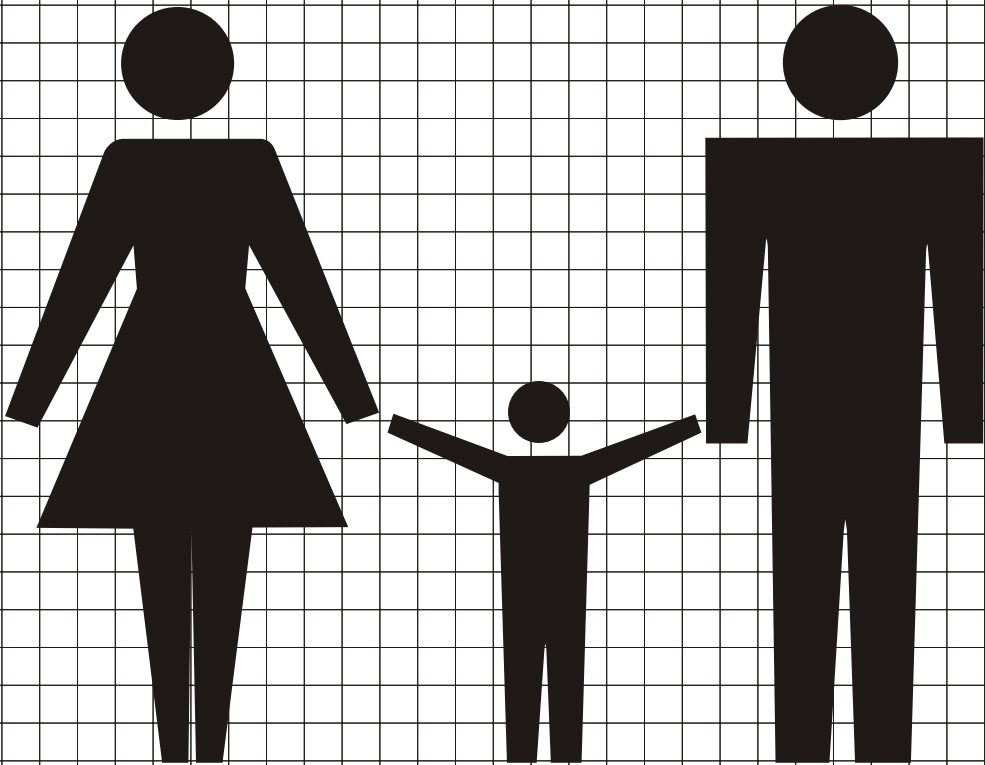

RA-150

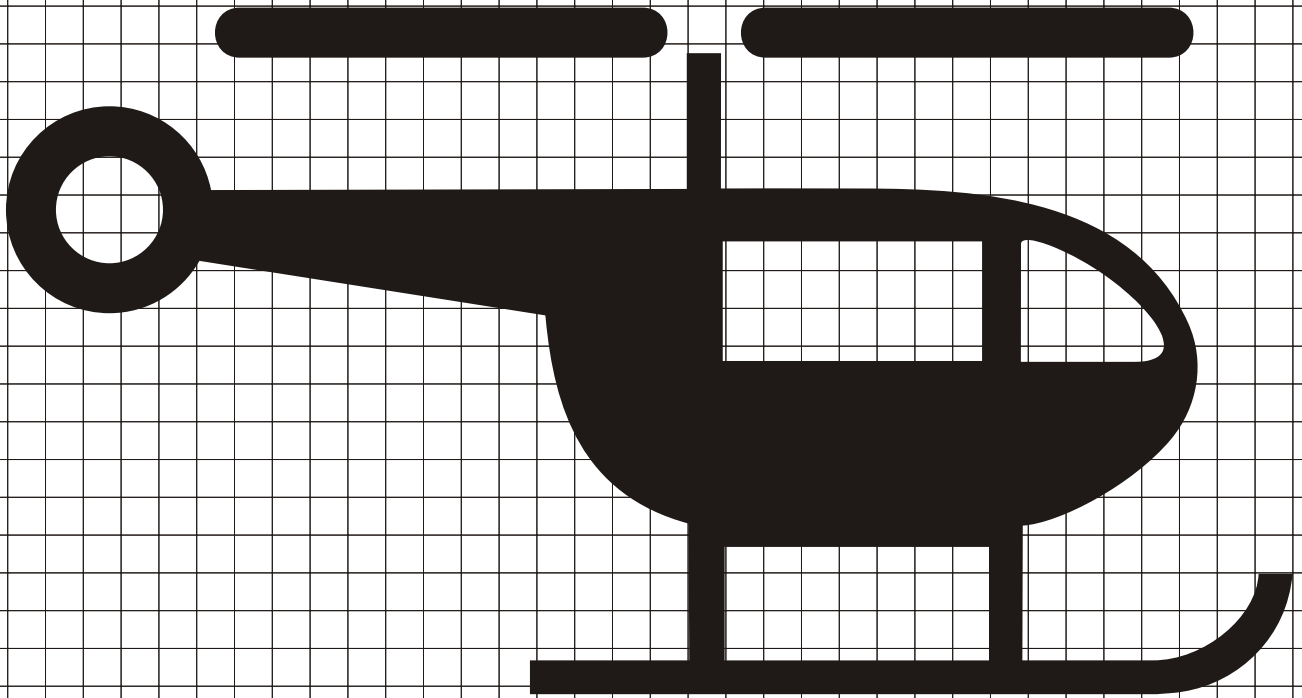

RA-160

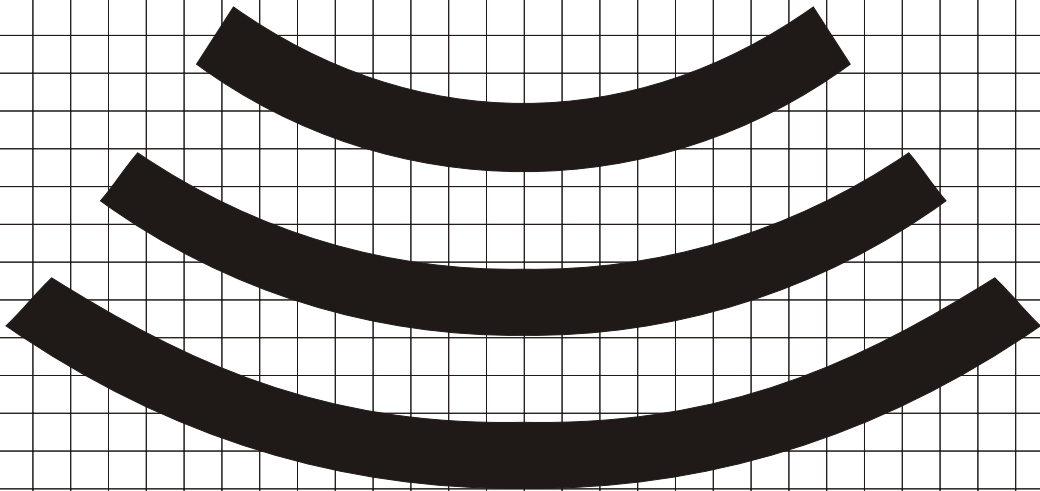

RL-010

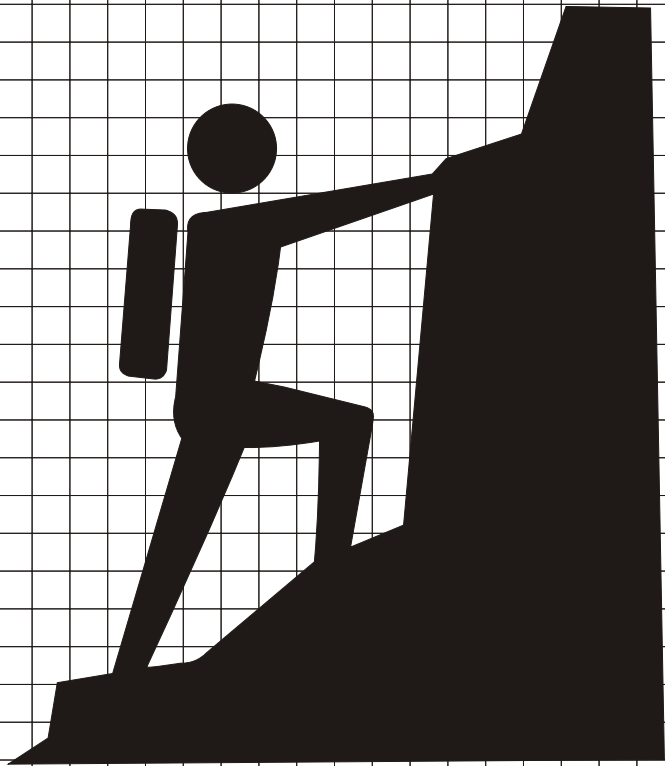

RL-020

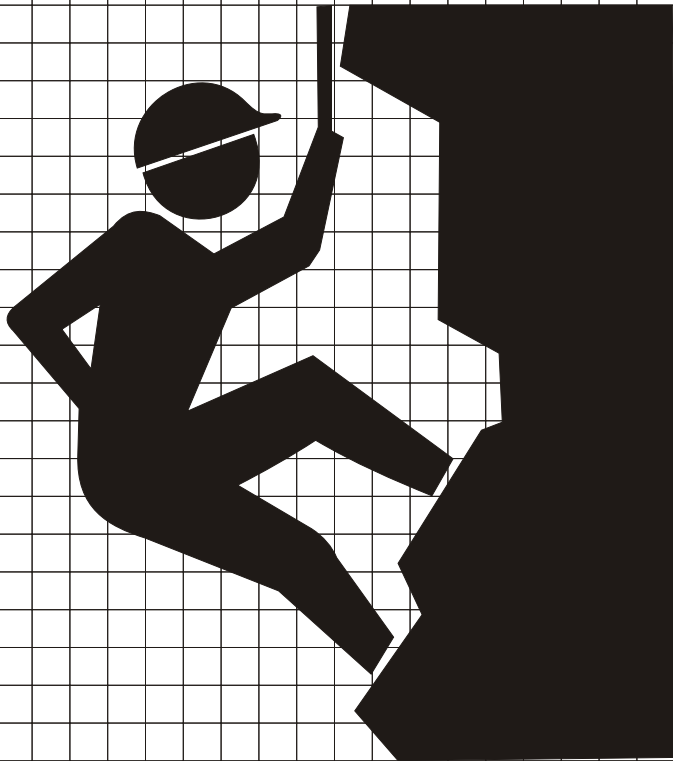

RL-030

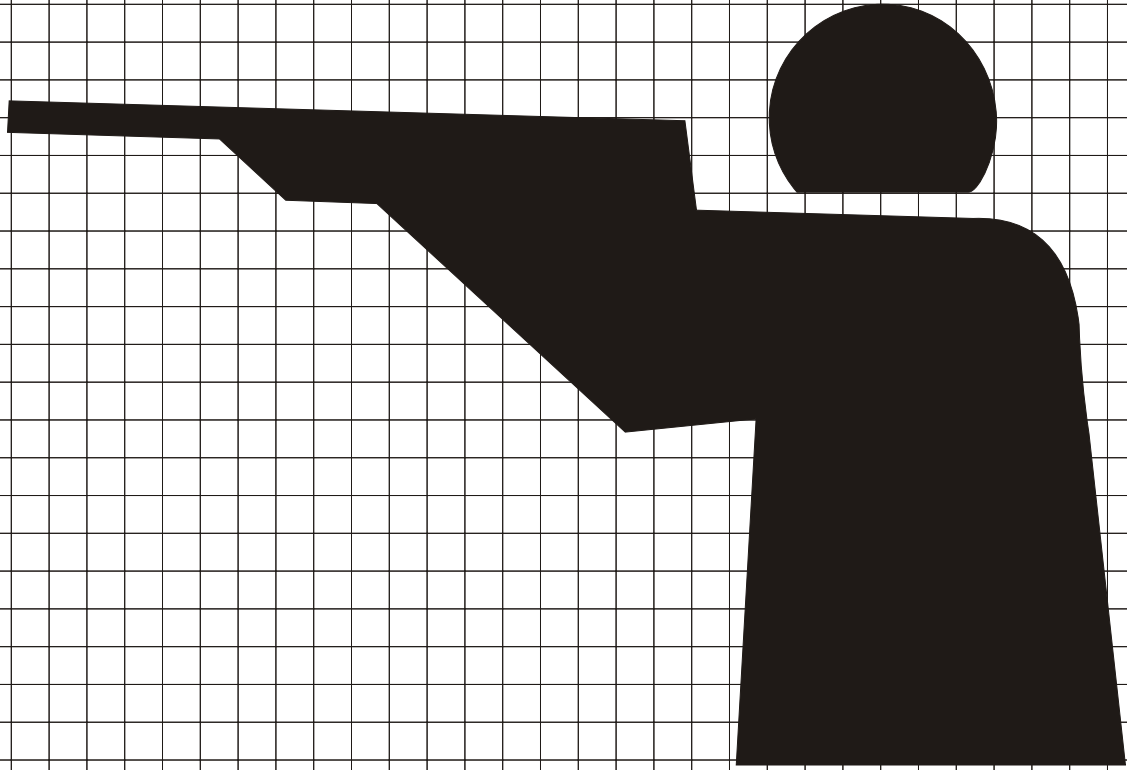

RL-040

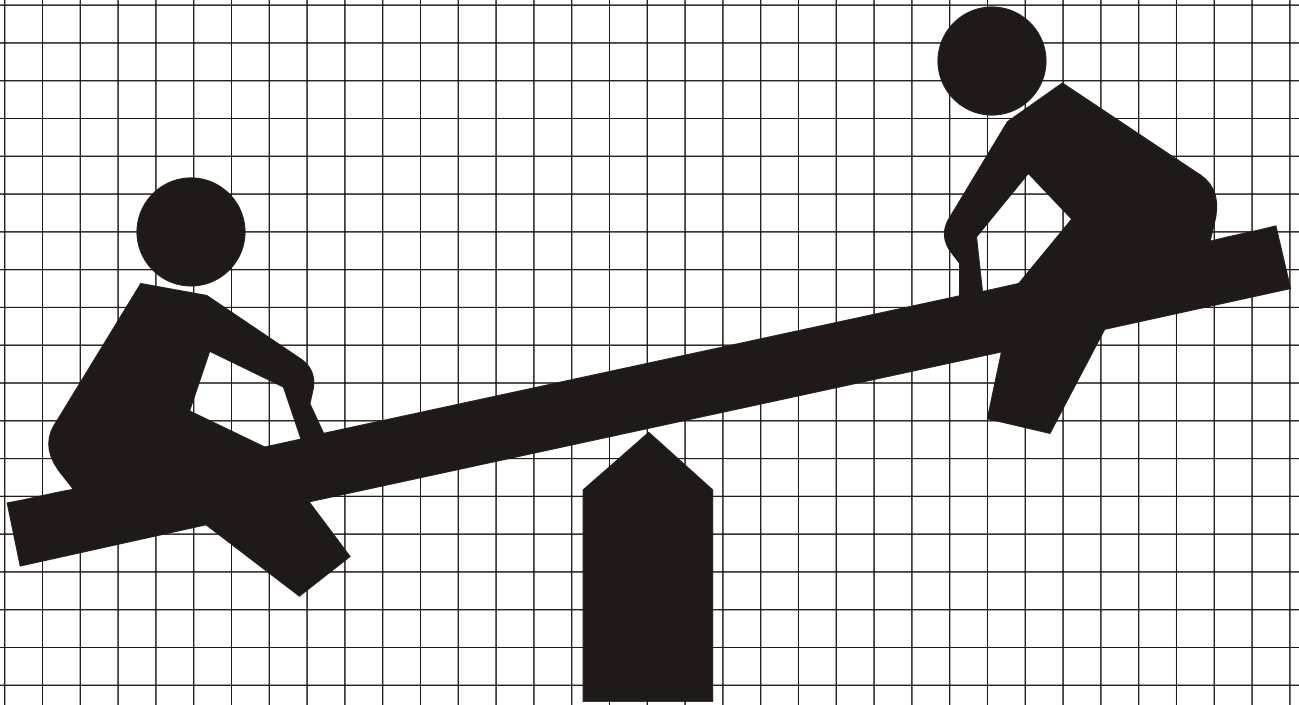

RL-050

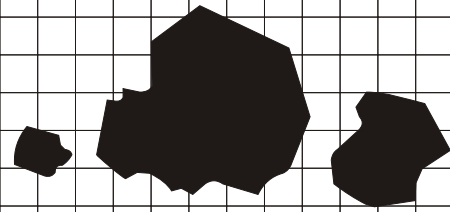
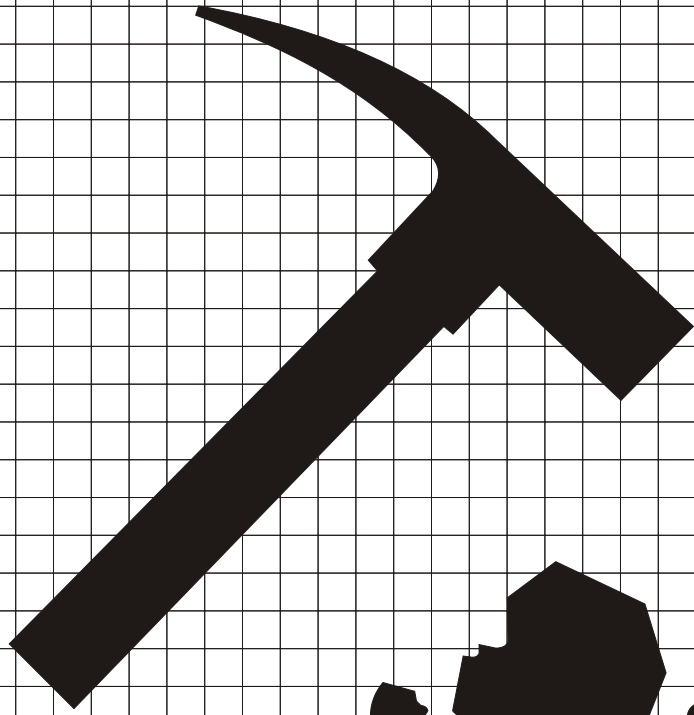

RL-060

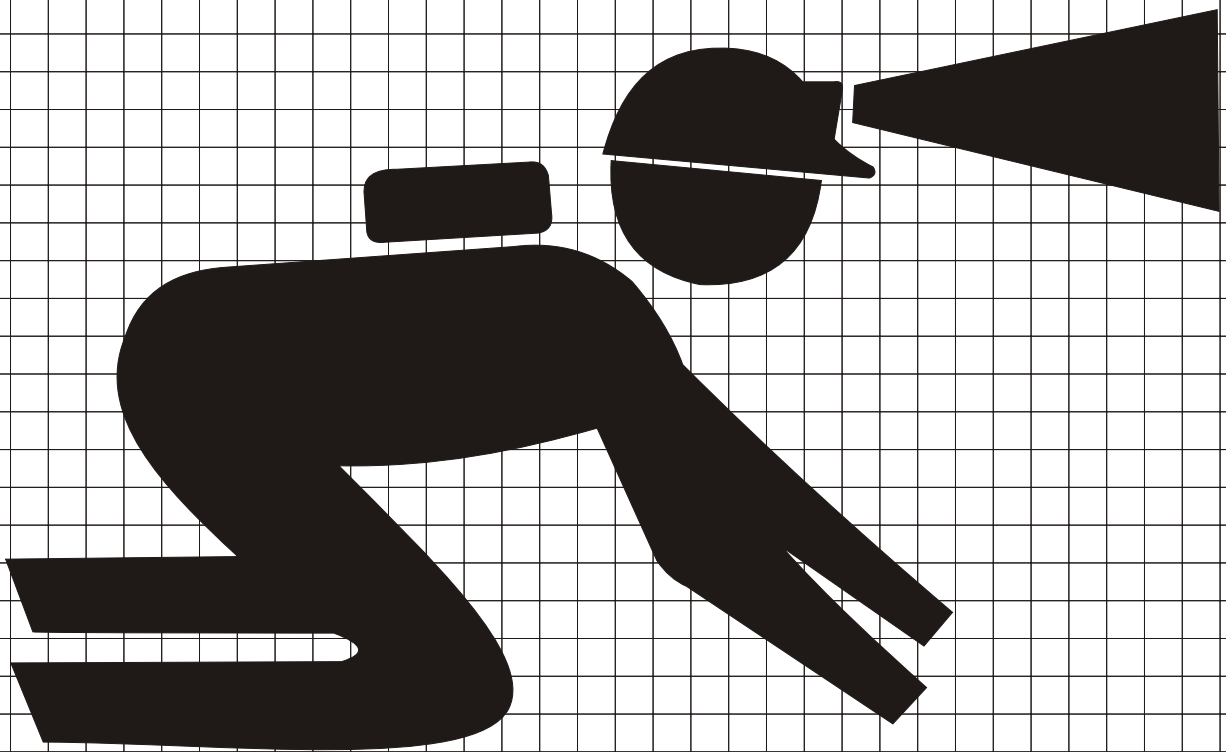

RL-070

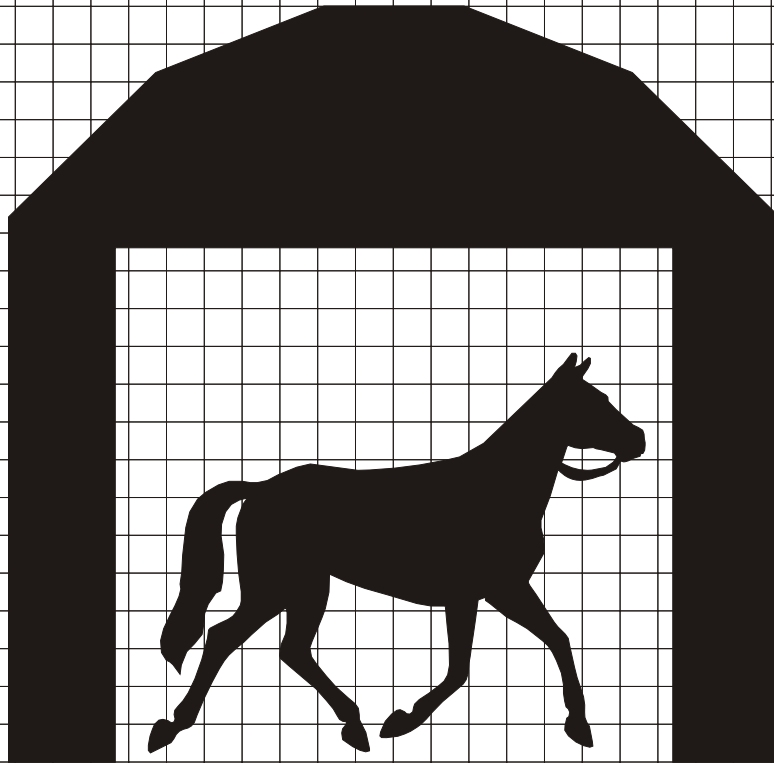

RL-080

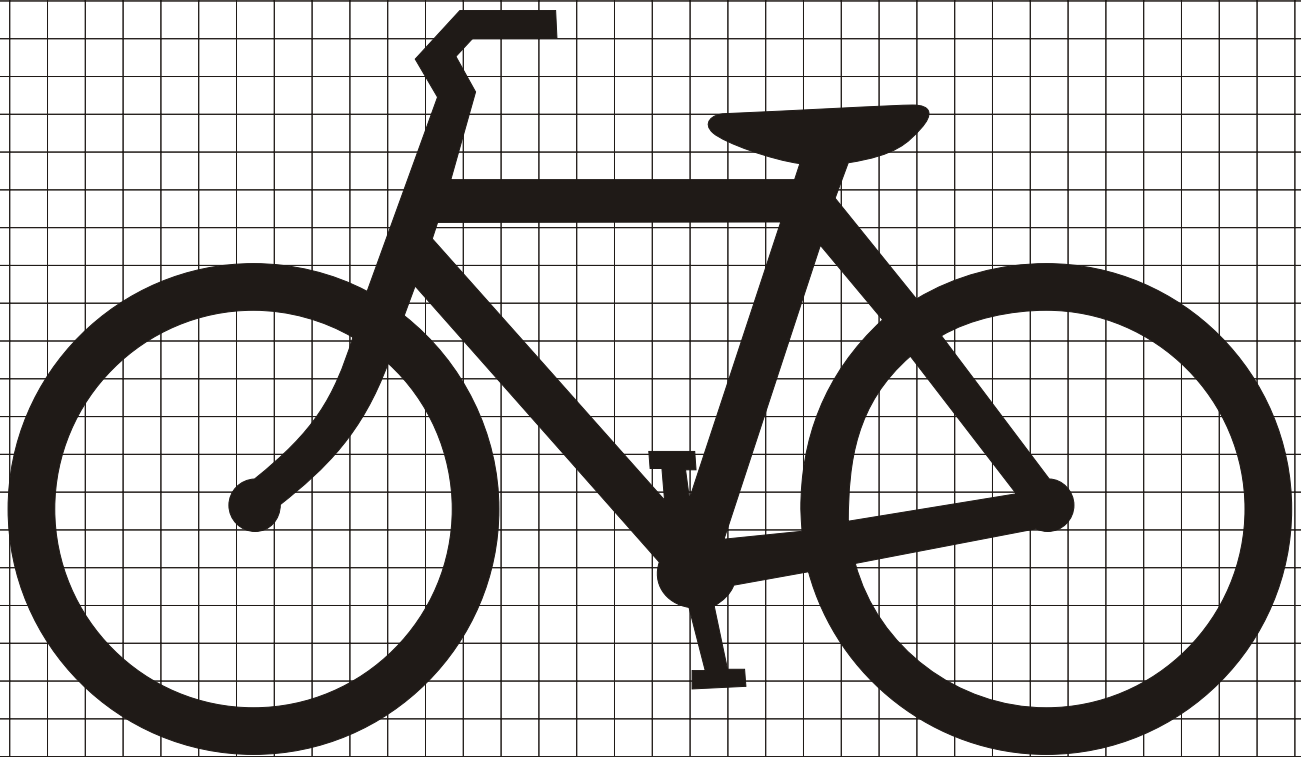

RL-090

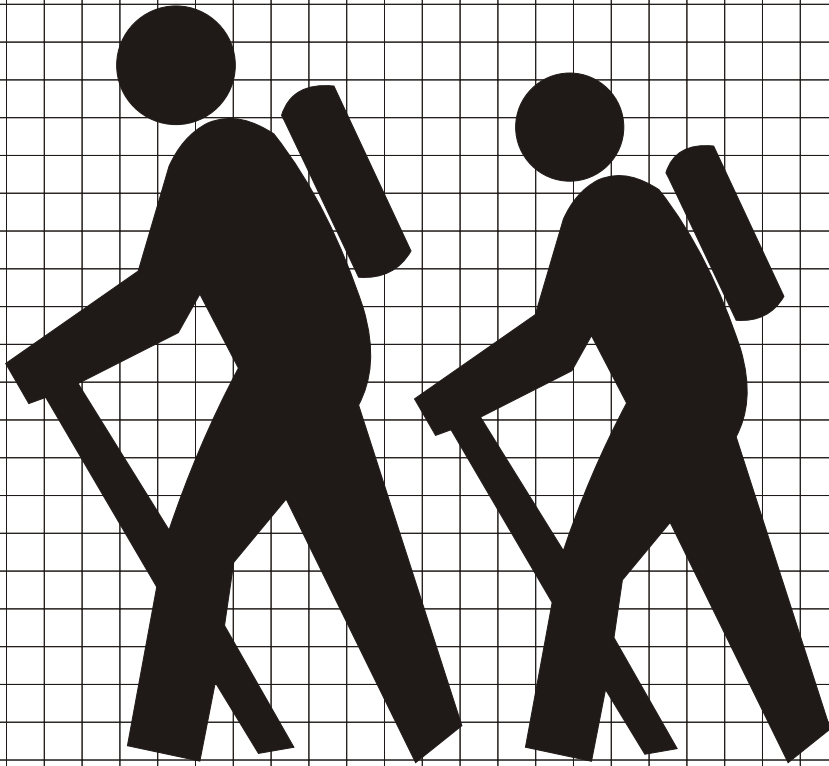

RL-100

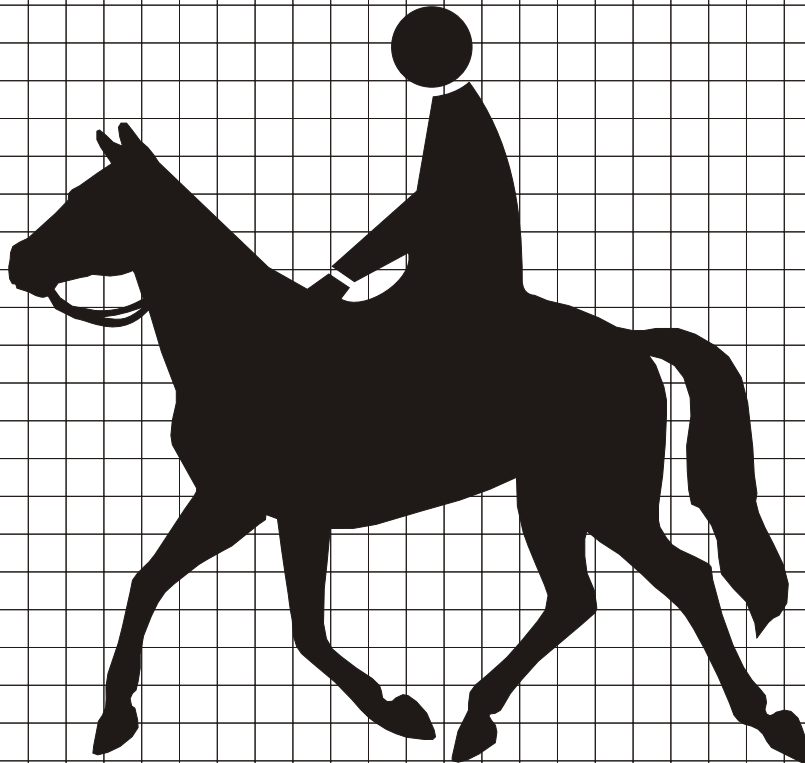

RL-110

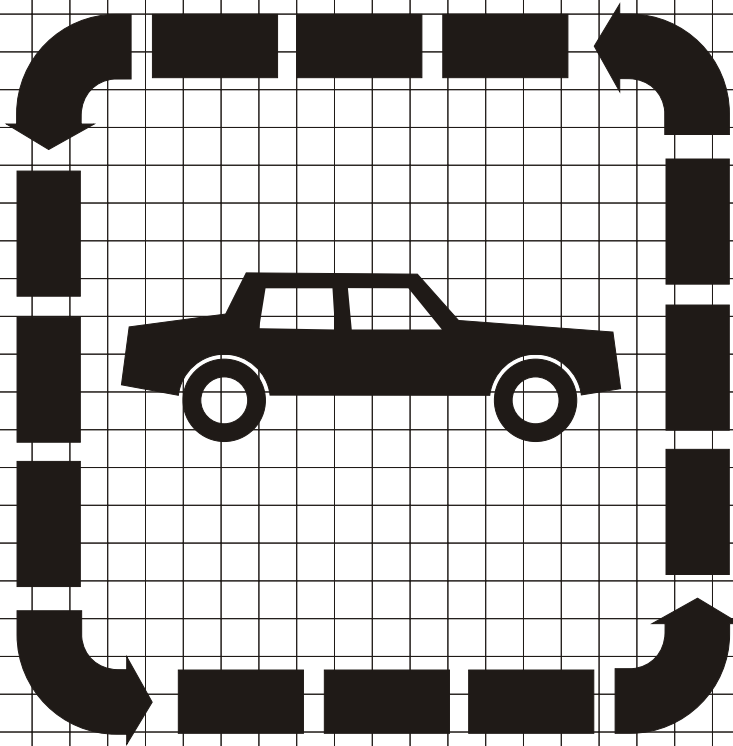

RL-120

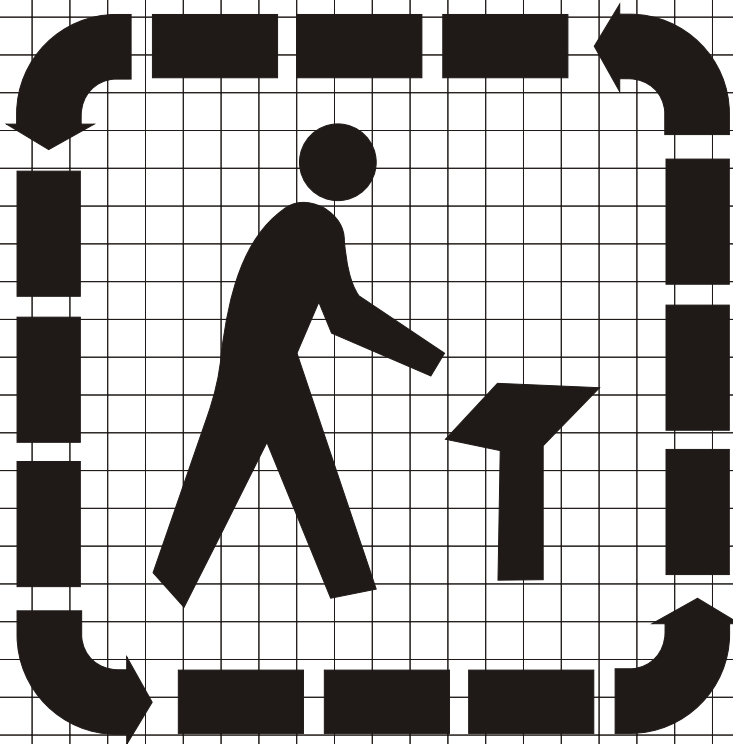

RL-130

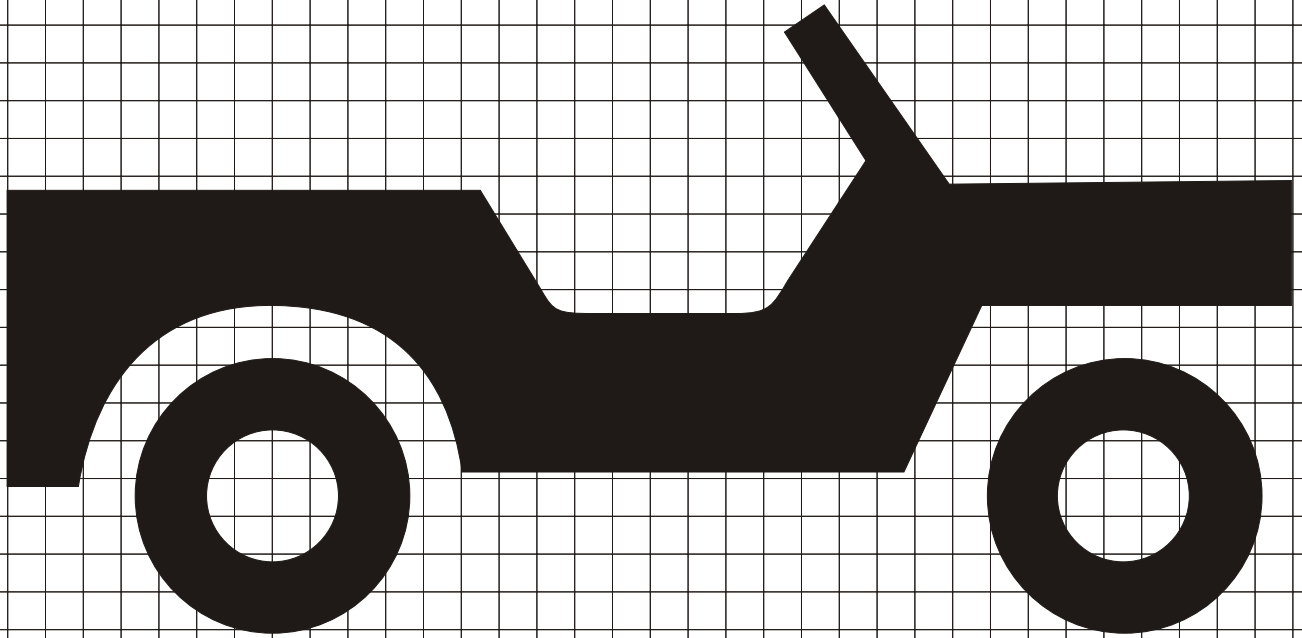

RL-140

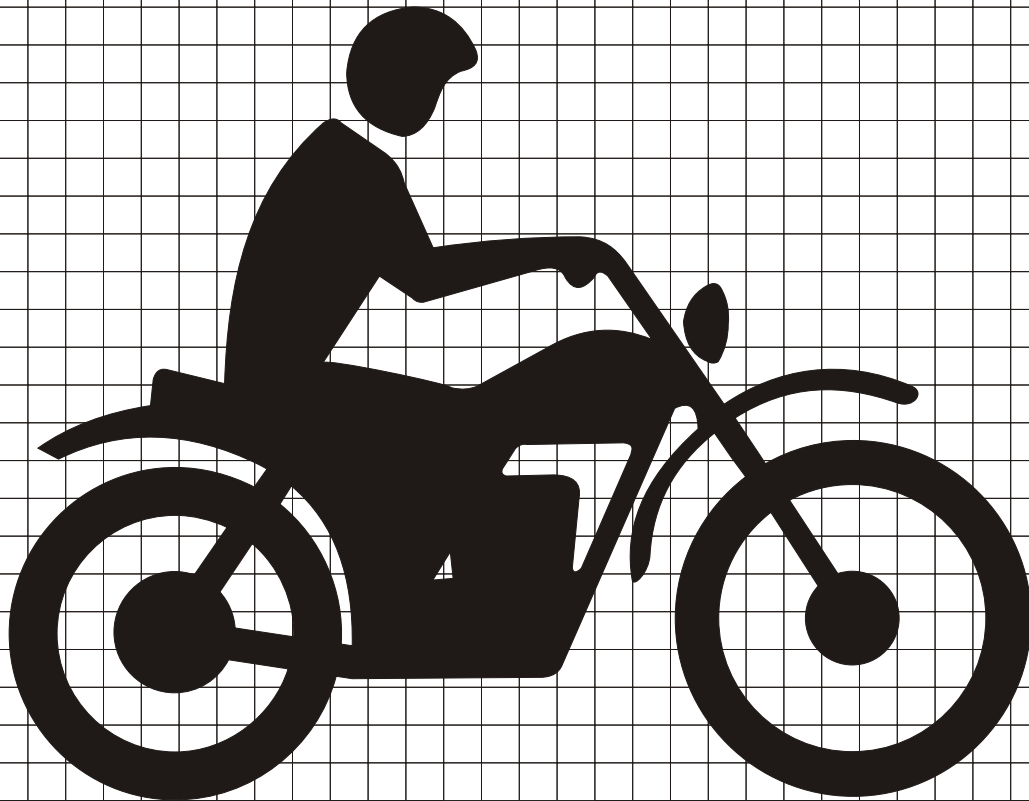

RL-150

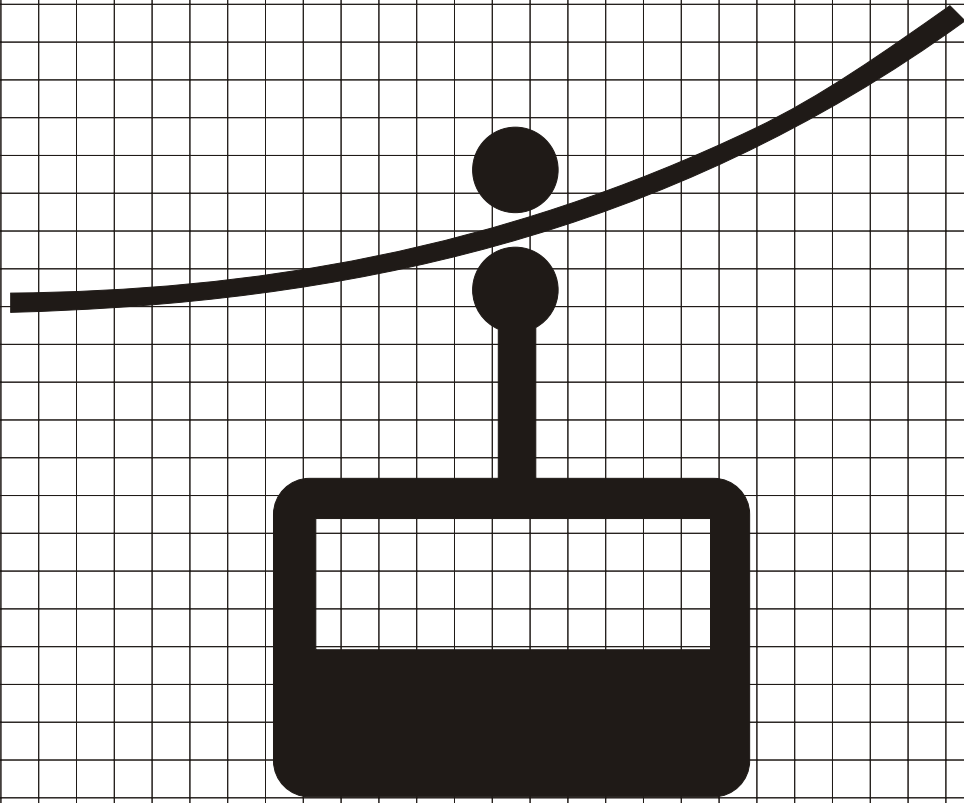

RL-160

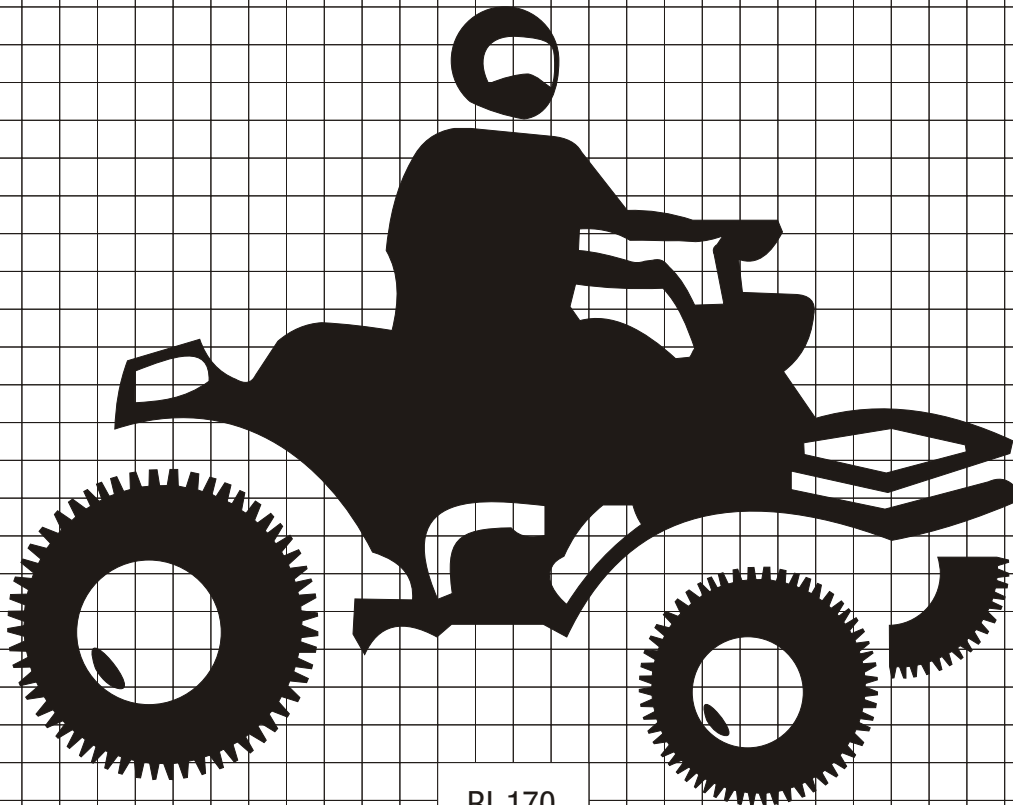

RL-170

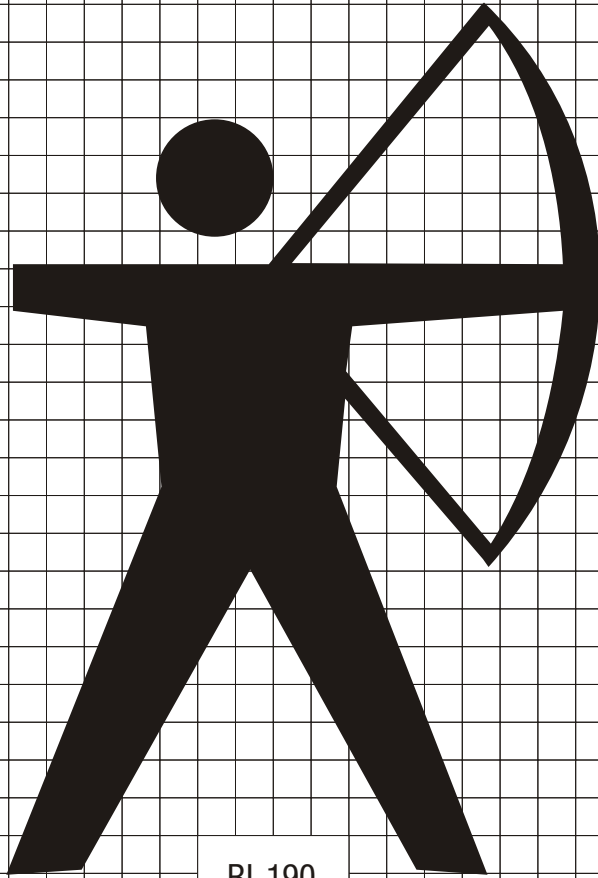

RL-190

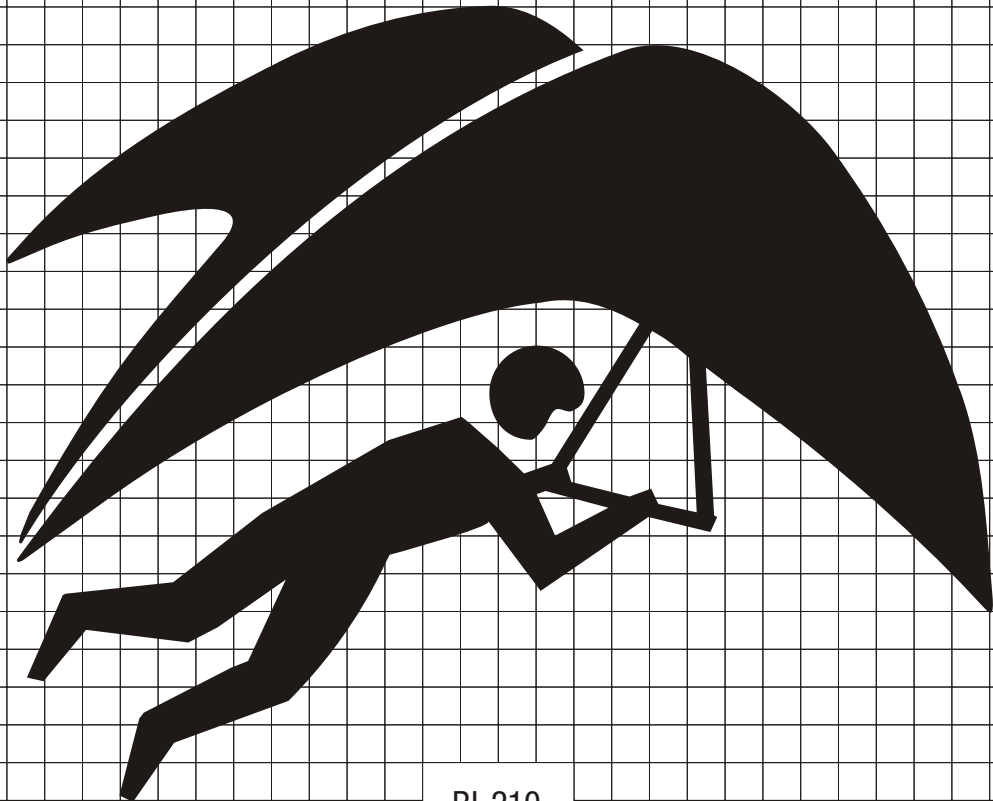

RL-210

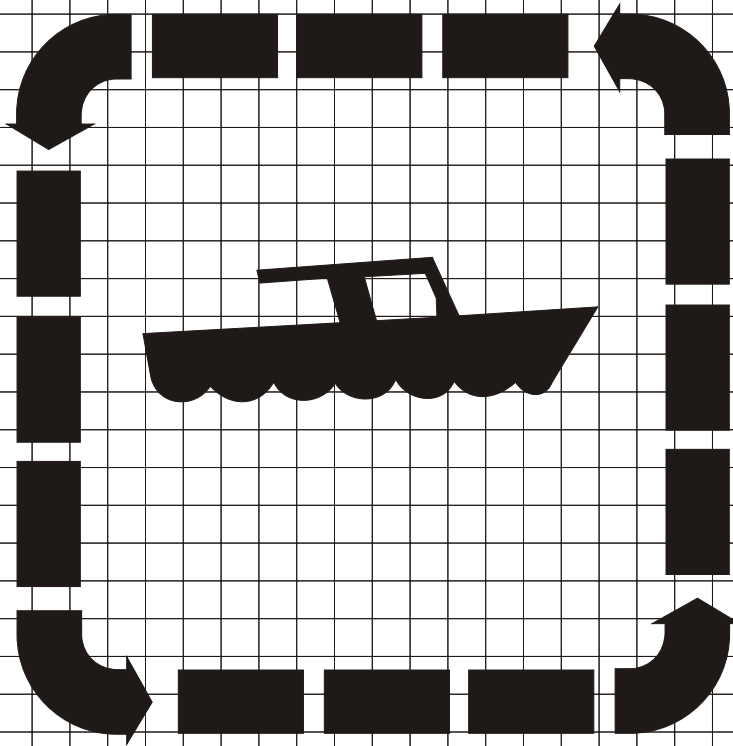

RW-010

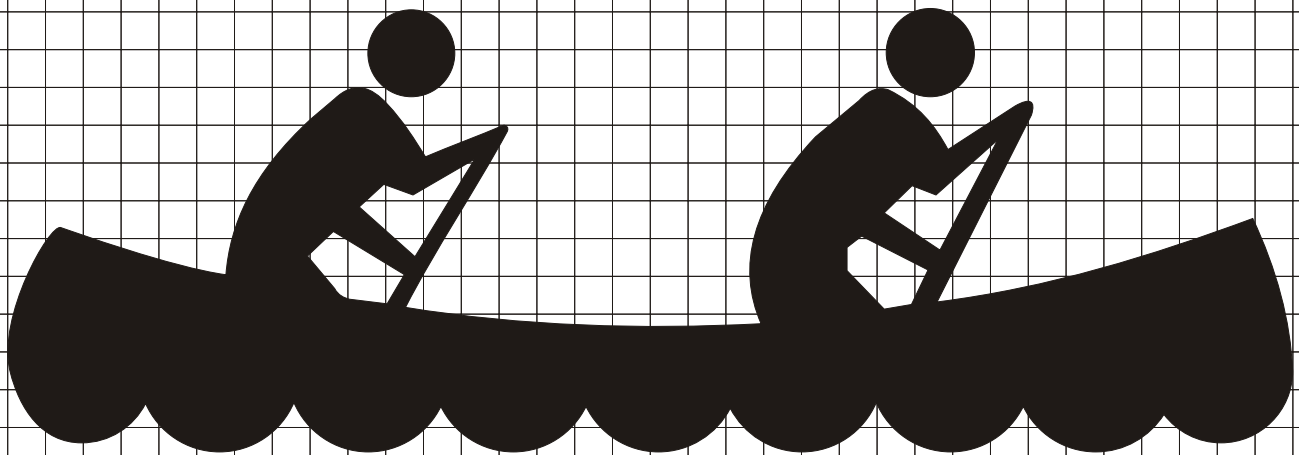

RW020

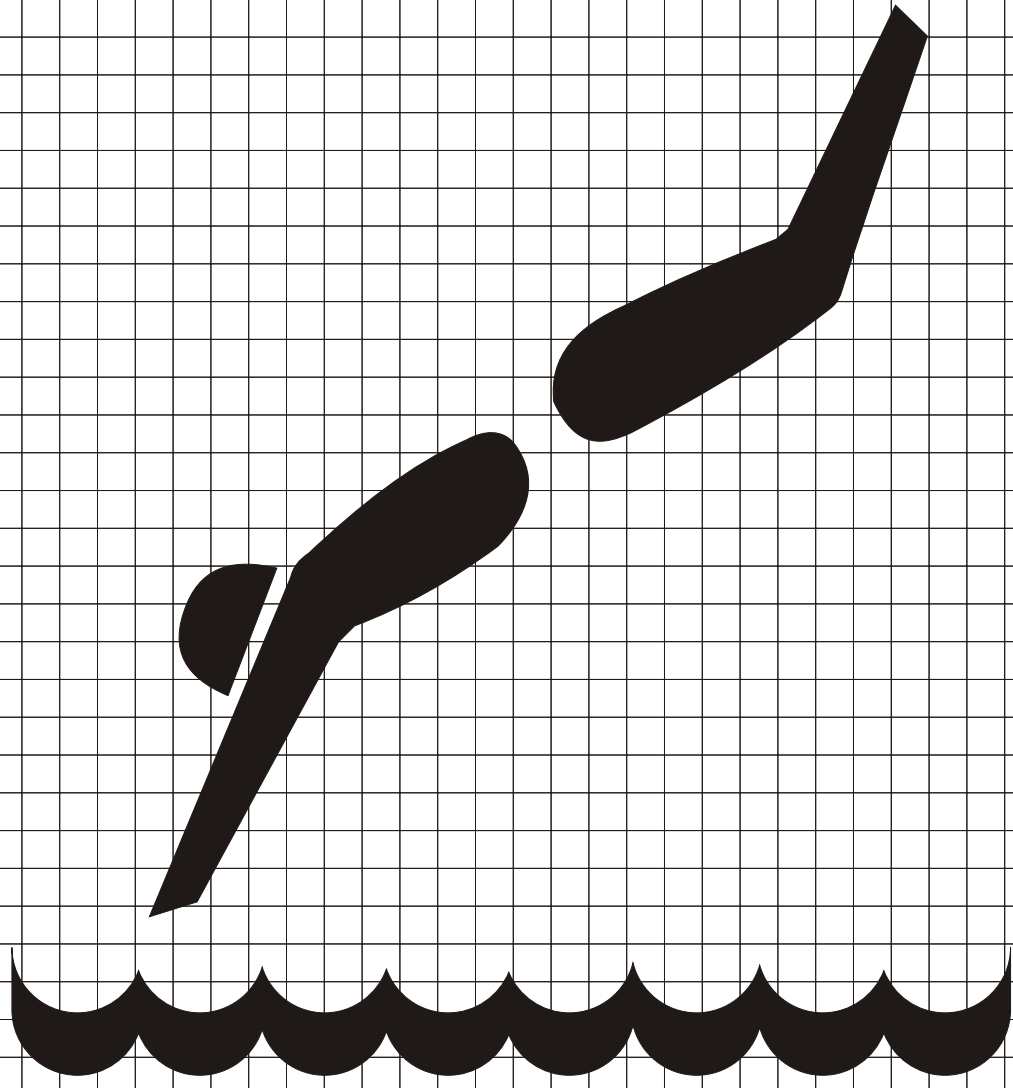

RW-030

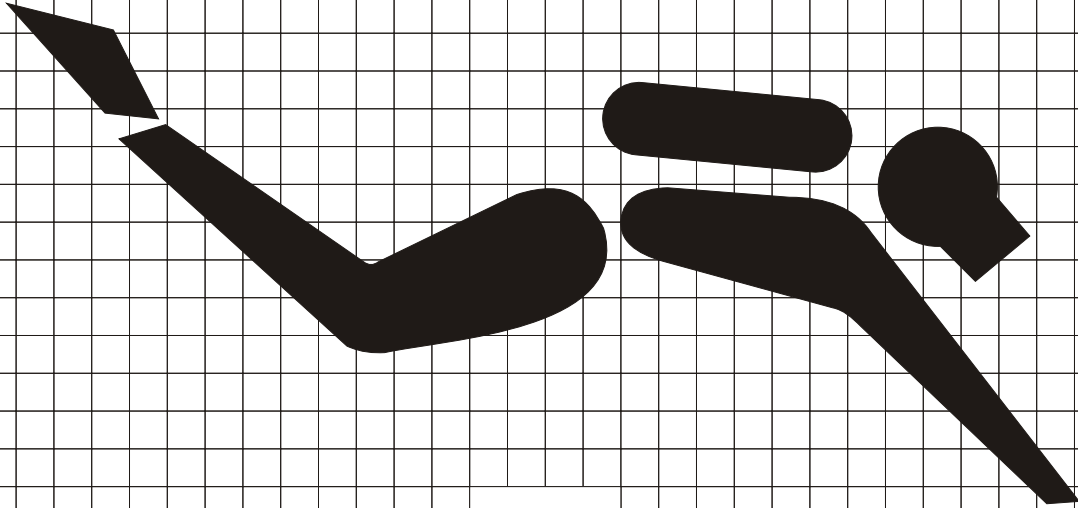

RW040

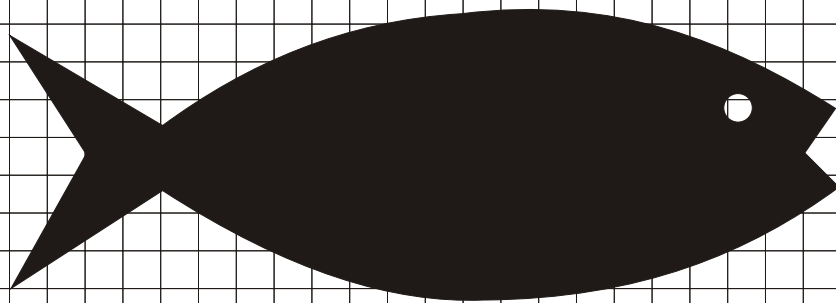

RW-050

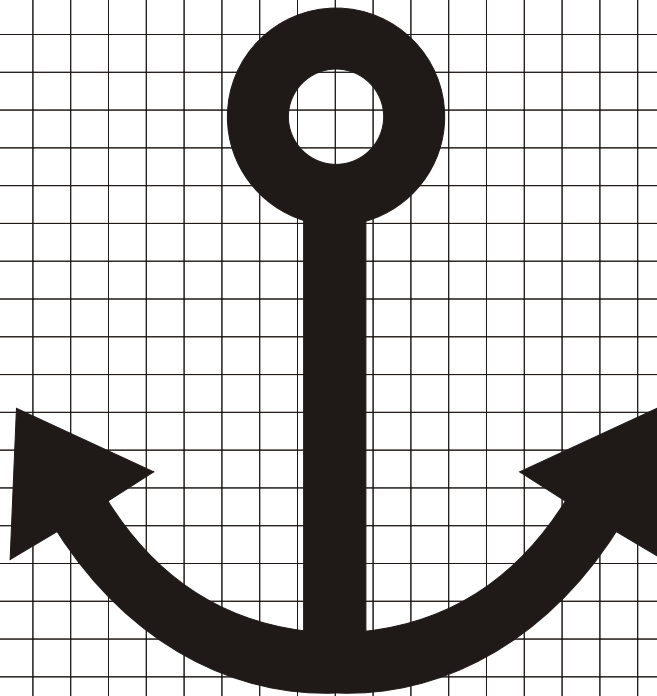

RW060

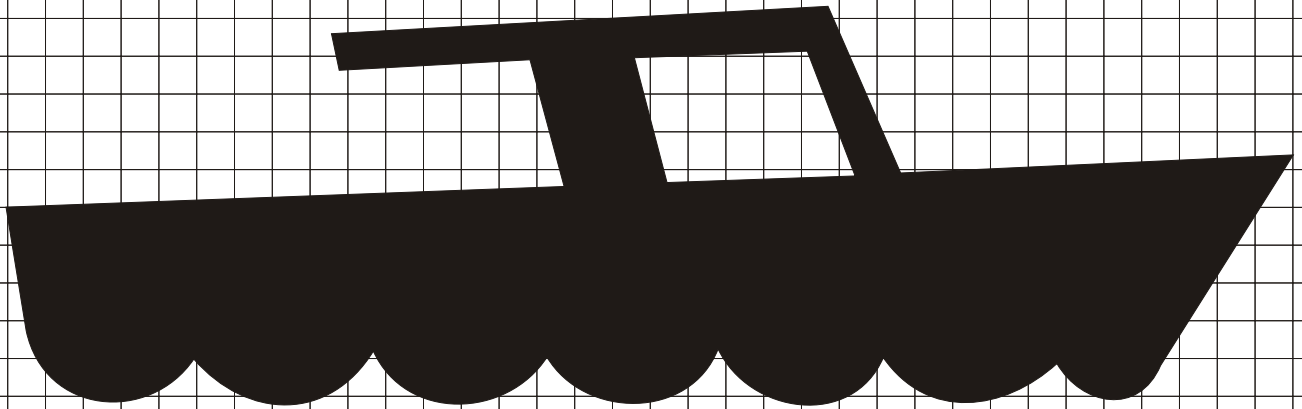

RW-070

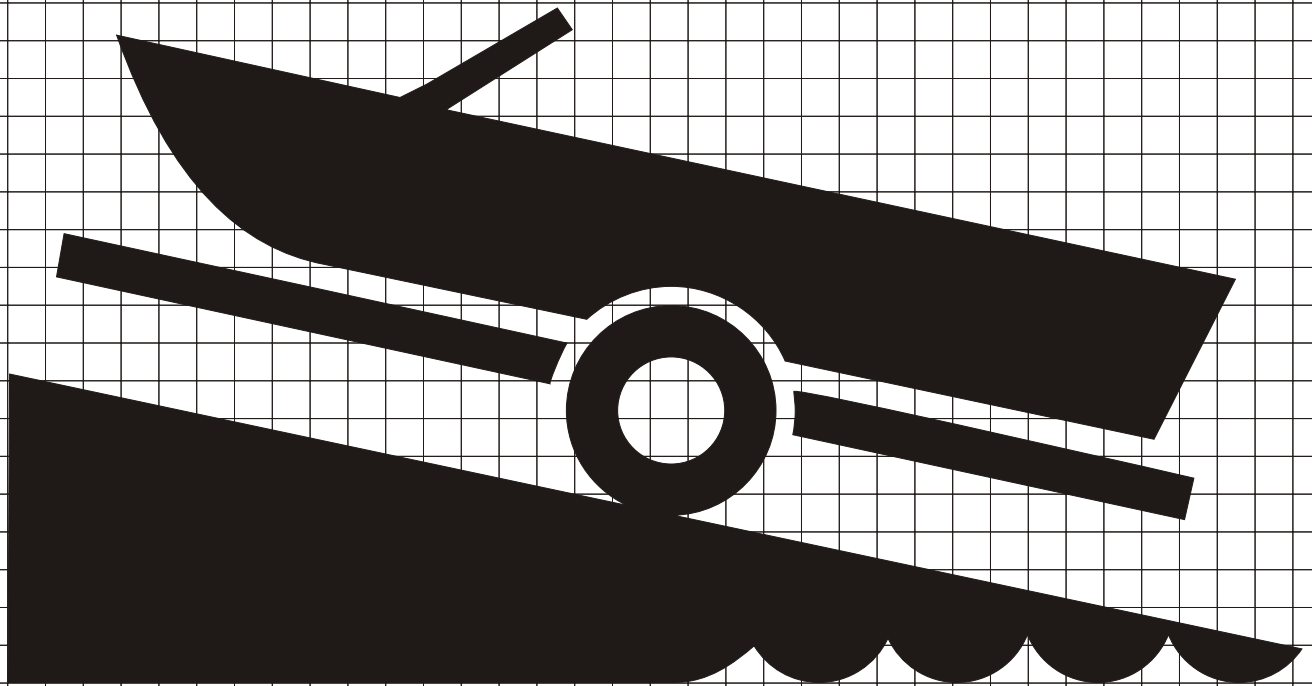

RW080

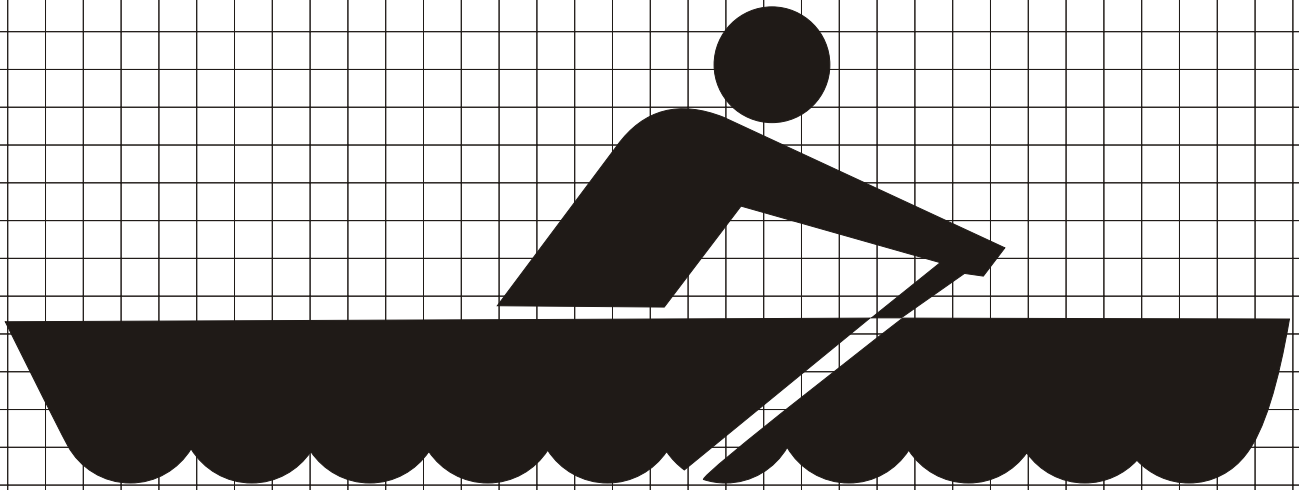

RW-090

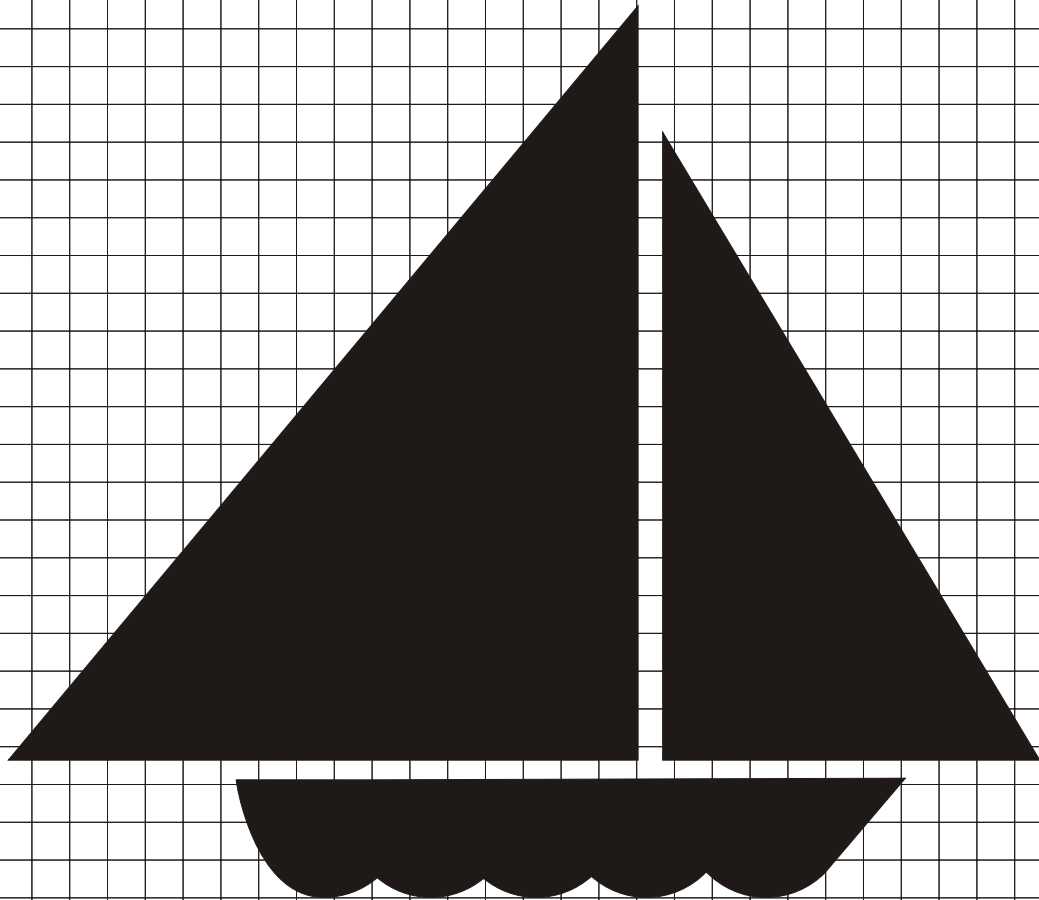

RW100

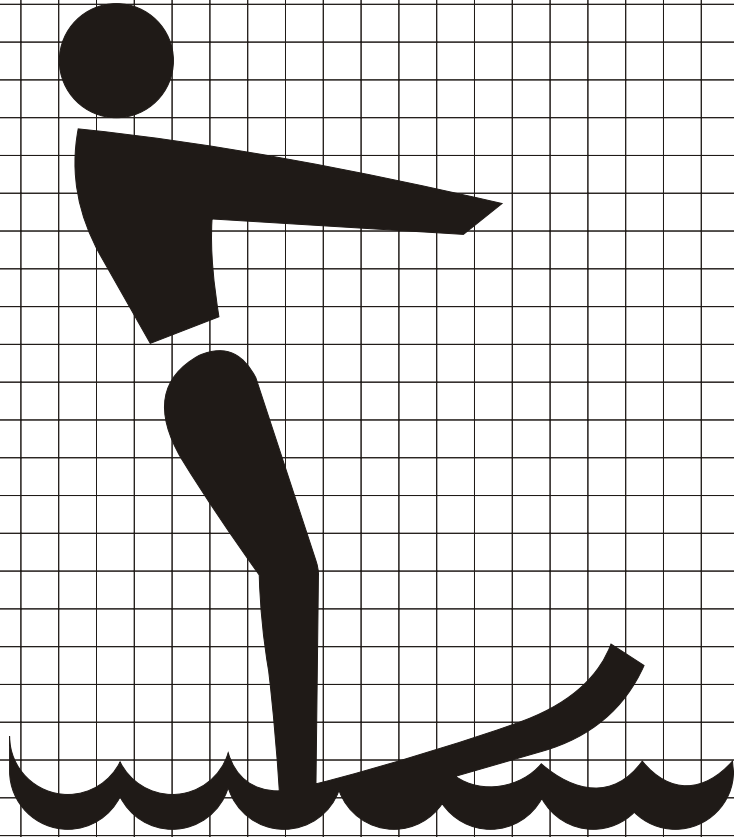

RW-110



RW120

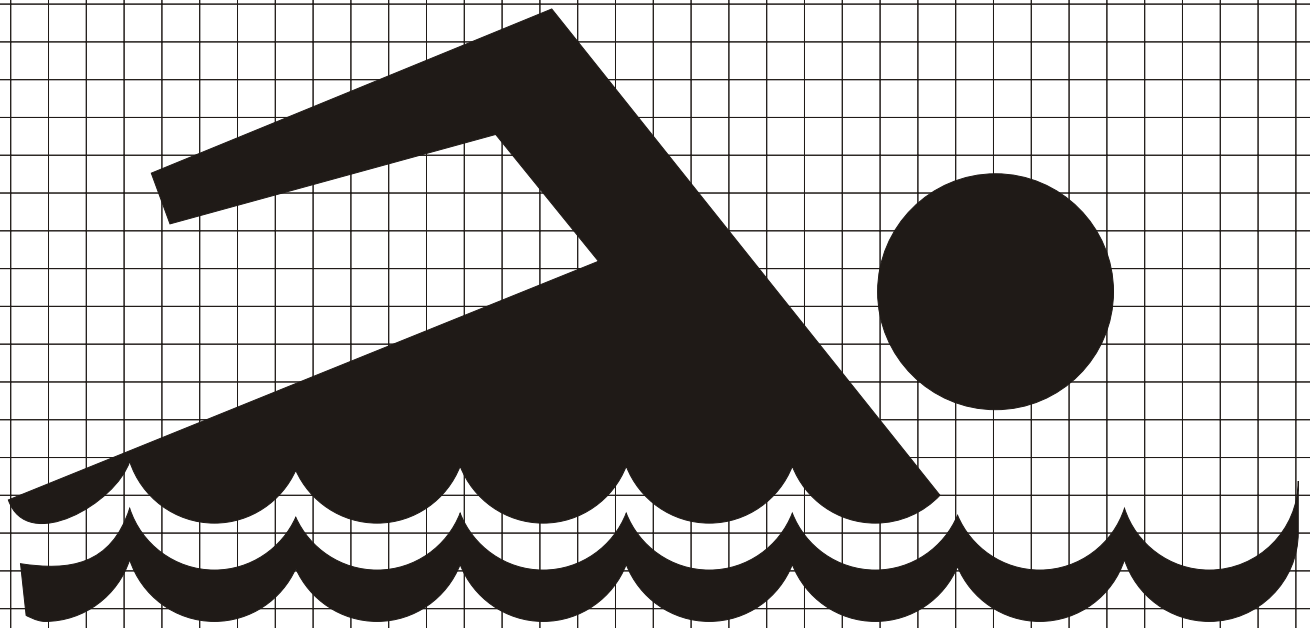

RW-130

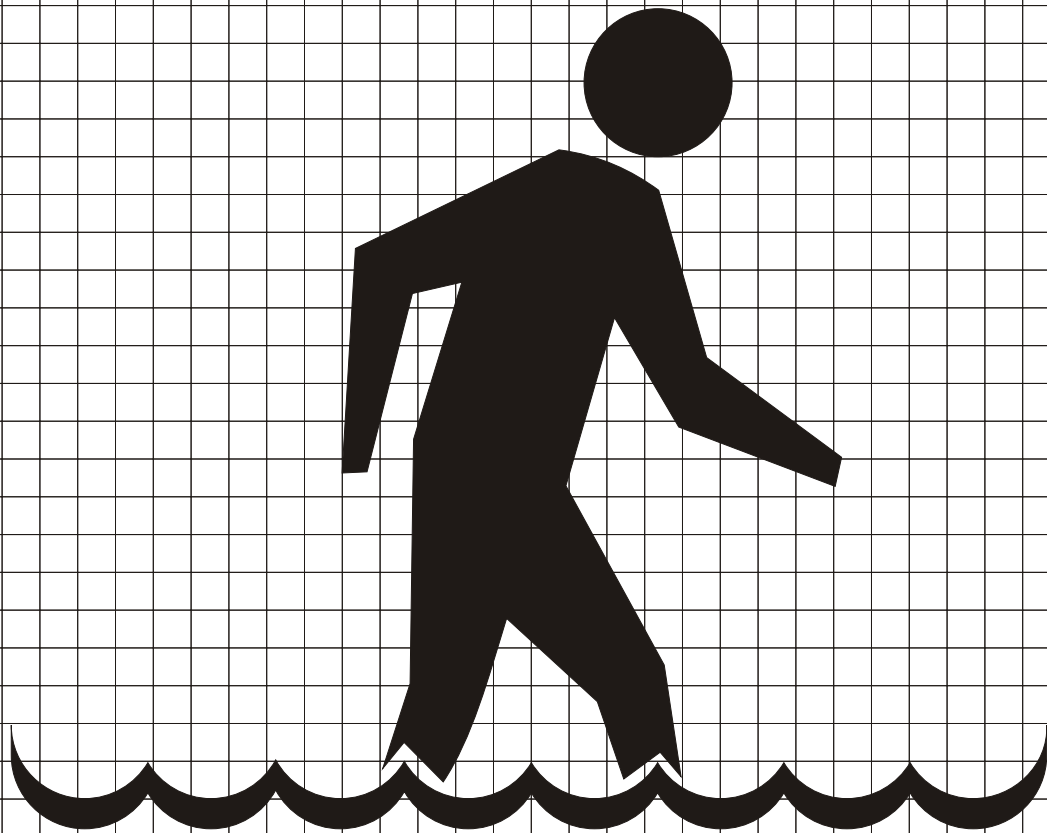

RW140

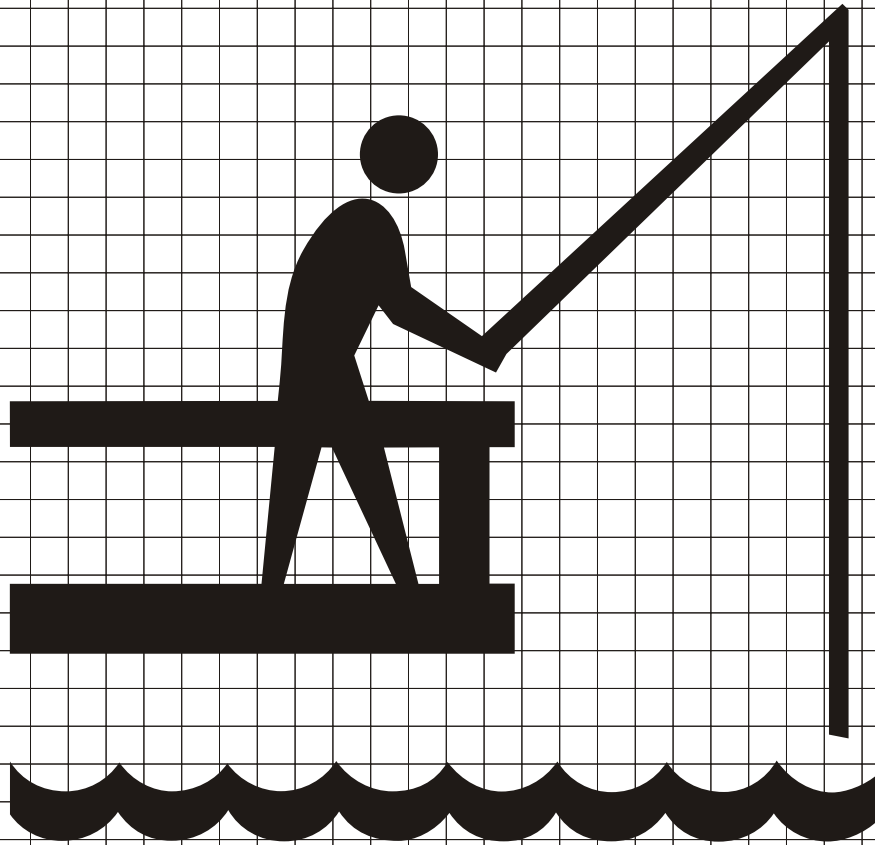

RW-160



RW170

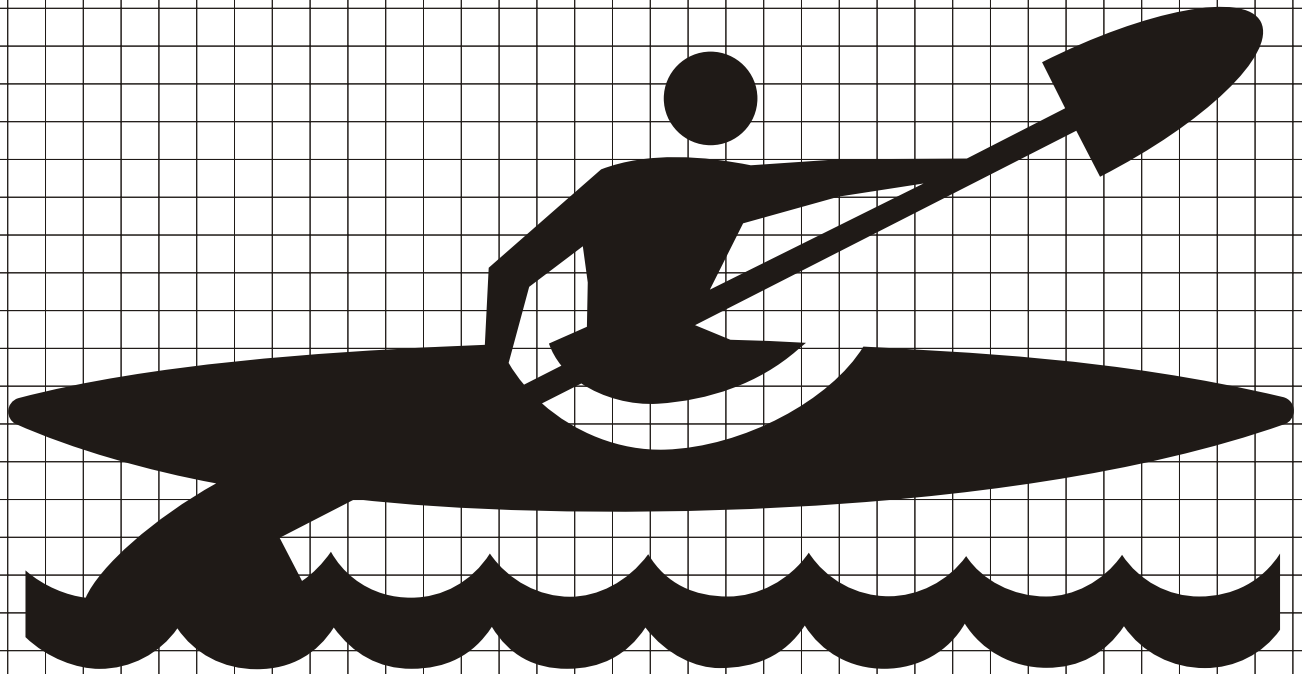

RW-190

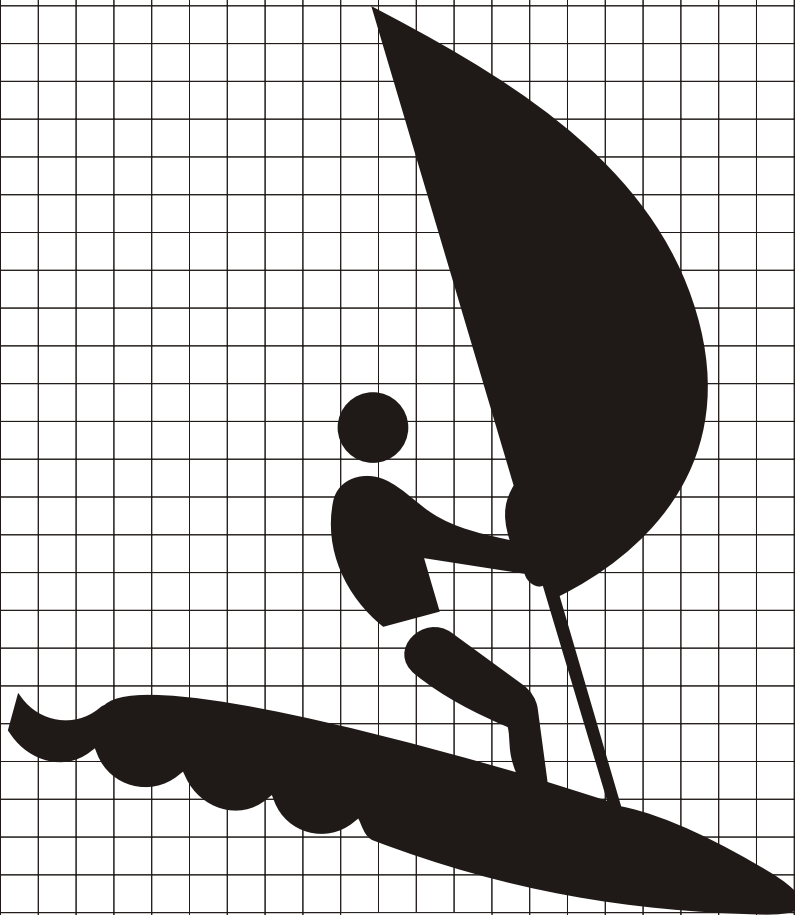

RW-210

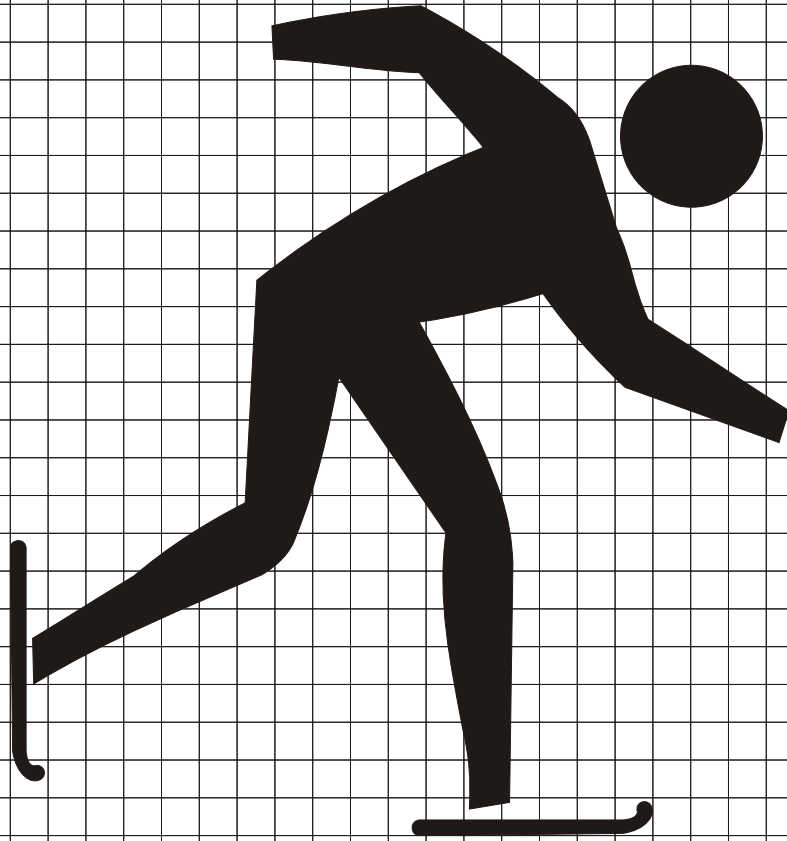

RS-010



RS-020



RS-030

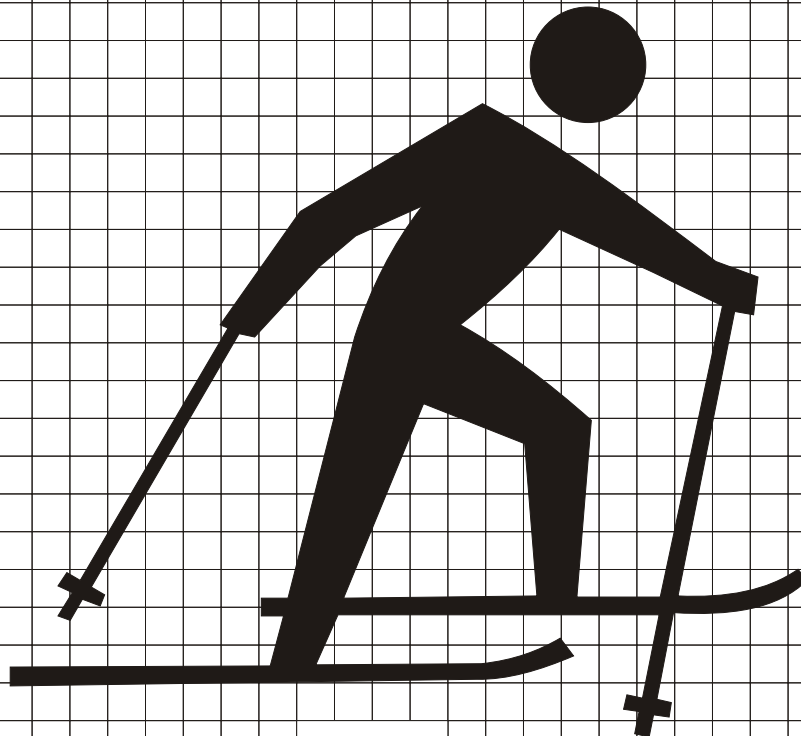

RS-040

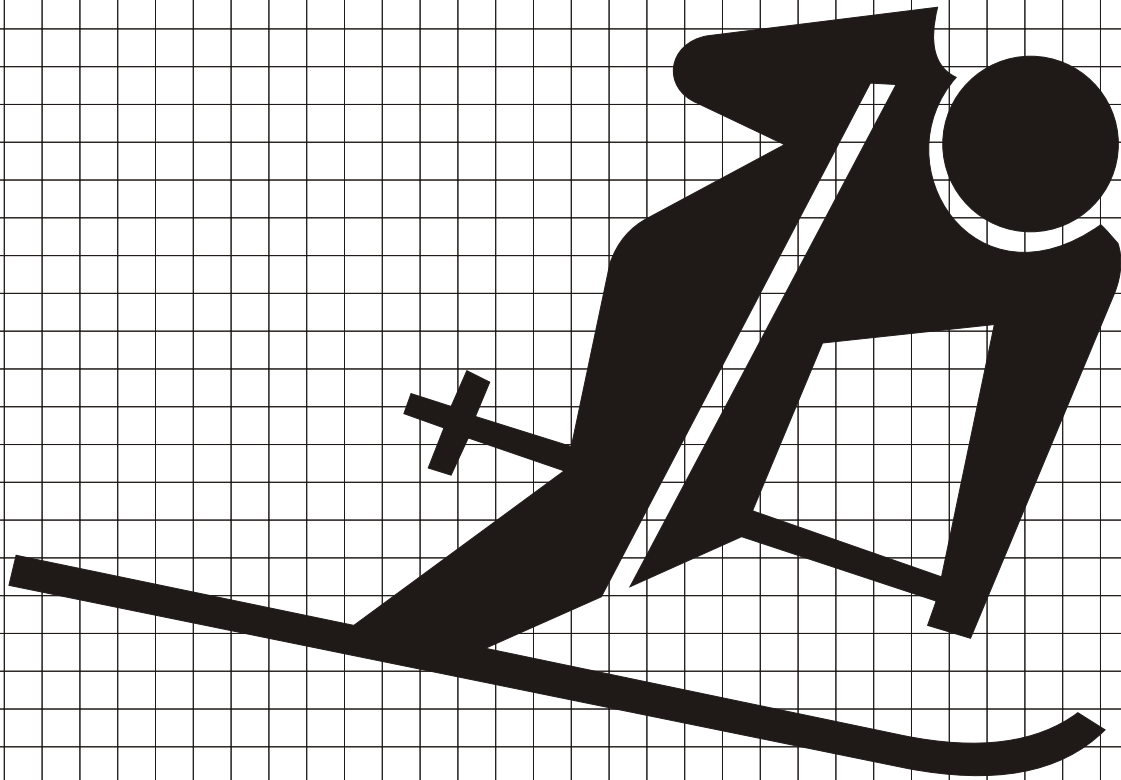

RS-050

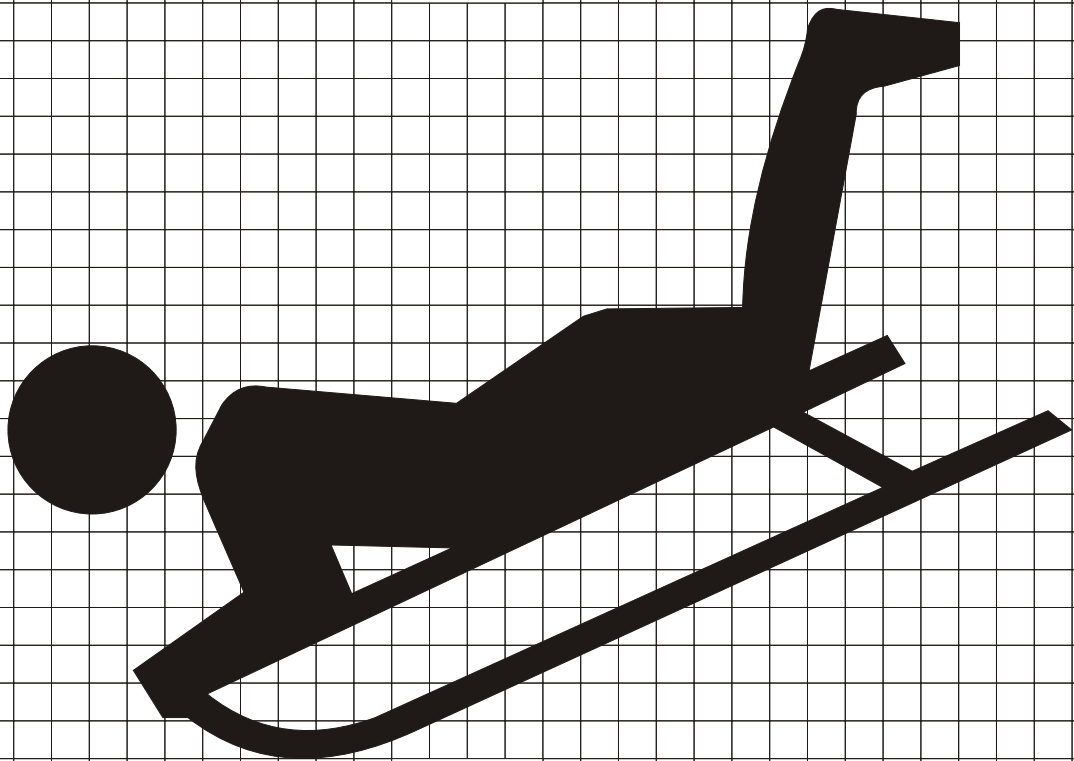

RS-060

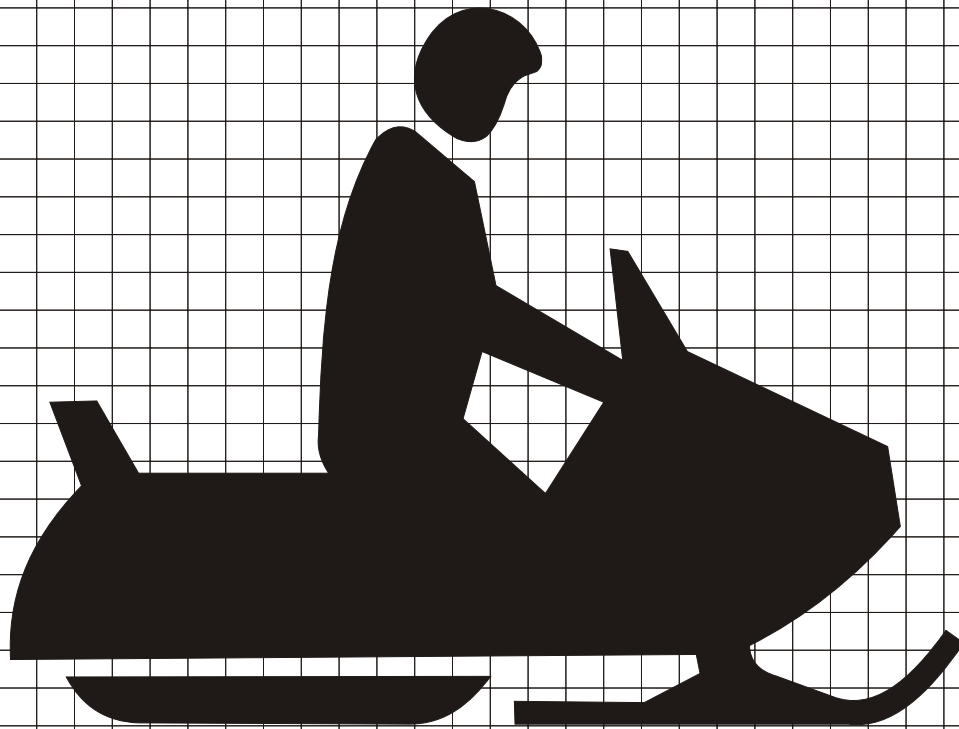

RS-070

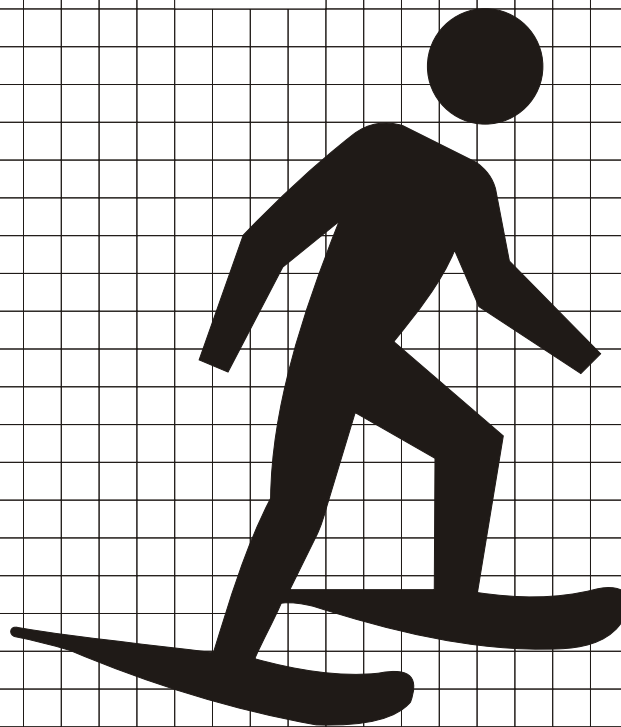

RS-080

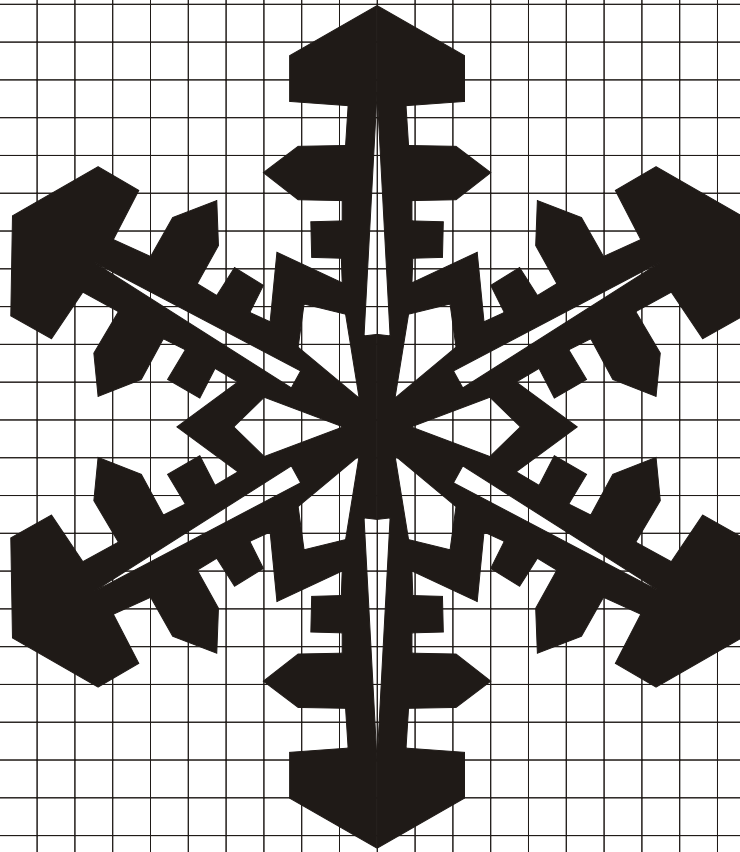

RS-090

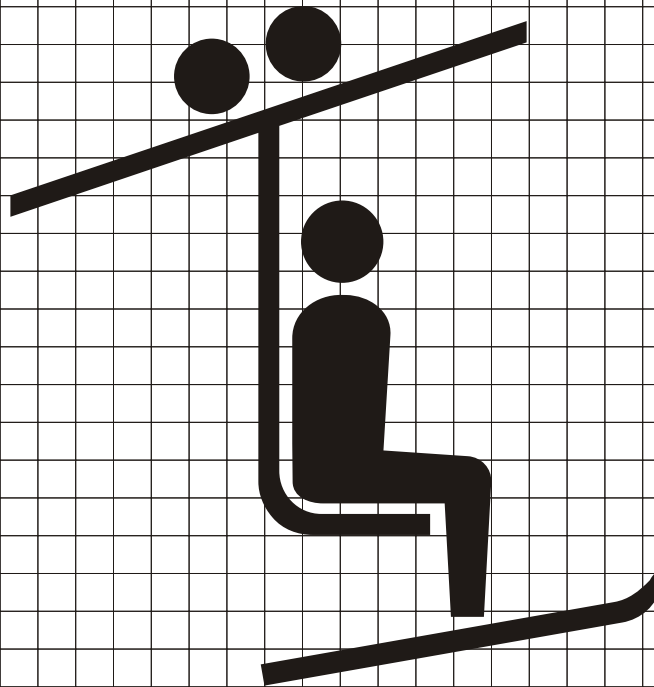

RS-100