

STANDARD ARROW DETAILS

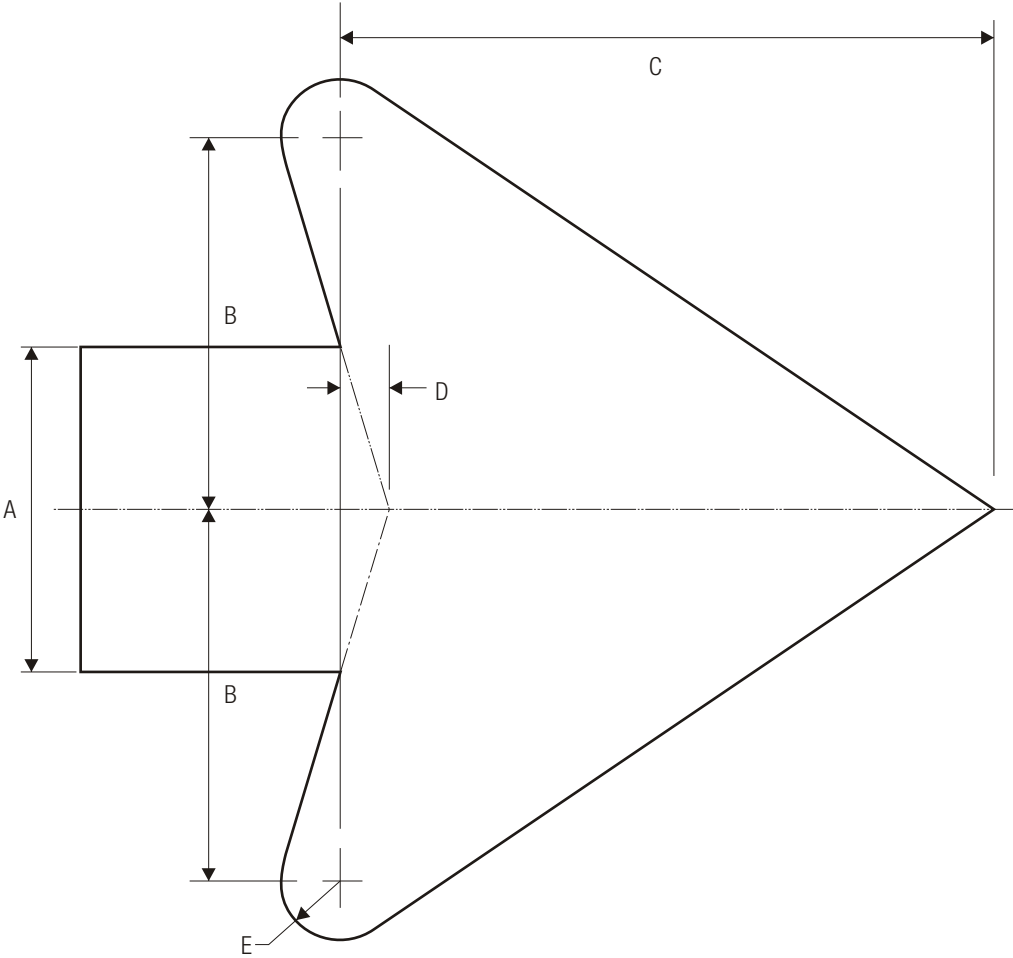

A	B	C	D	E
2	2.313	4.313	.313	.375
2.25	2.625	4.5	.375	.438
2.5	2.875	5.063	.375	.5
2.625	3	5.25	.375	.5
2.75	3	5.563	.438	.563
3	3.5	6.125	.438	.563
3.125	3.625	6.375	.5	.625
3.25	3.75	6.625	.5	.625
3.313	3.813	6.688	.5	.688
3.5	4	7.125	.563	.688
3.75	4.313	7.625	.563	.75
4	4.625	8.125	.625	.813
4.063	4.75	8.25	.625	.813
4.25	4.875	8.625	.625	.813
4.375	5	8.875	.688	.875
4.5	5.188	9.125	.688	.875

A	B	C	D	E
4.75	5.438	9.625	.75	1
4.875	5.625	9.875	.75	1
5	5.75	10.125	.75	1
5.25	6	10.625	.813	1.063
5.5	6.375	11.125	.875	1.125
5.75	6.625	11.688	.875	1.125
6	6.875	12.188	.938	1.188
6.5	7.5	13.188	1	1.625
7	8	14.188	1.063	1.375
7.5	8.625	15.188	1.125	1.5
8	9.188	16.25	1.25	1.625

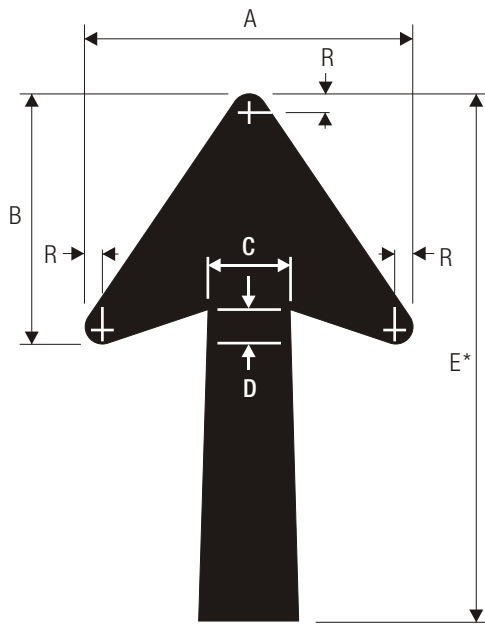

UP ARROW

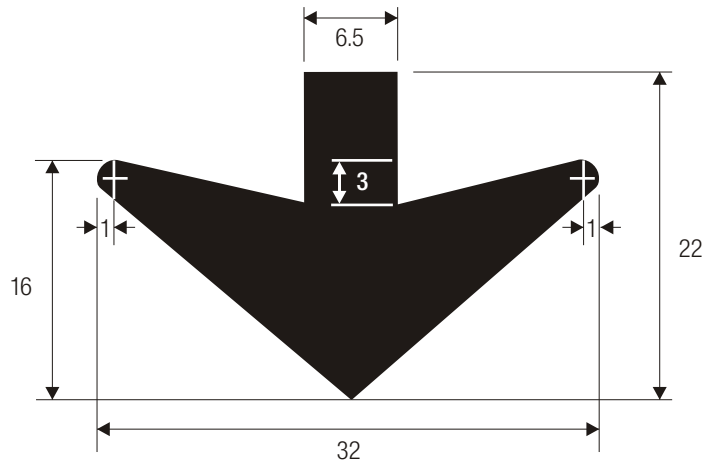

DOWN ARROW

ARROWS FOR GUIDE SIGNS

Dimensions of Arrow When Used With Various Letter Cap Heights.

Letter Size	A	B	C	D	E*	R
8	15.125	11.563	3.75	1.313	17-25	.813
10-13.3	18.25	14	4.5	1.5	20-30	.75
16	22.25	17	5.375	1.75	25-35	1

*Taper of .5" per ft. should be held constant for longer or shorter shaft lengths.

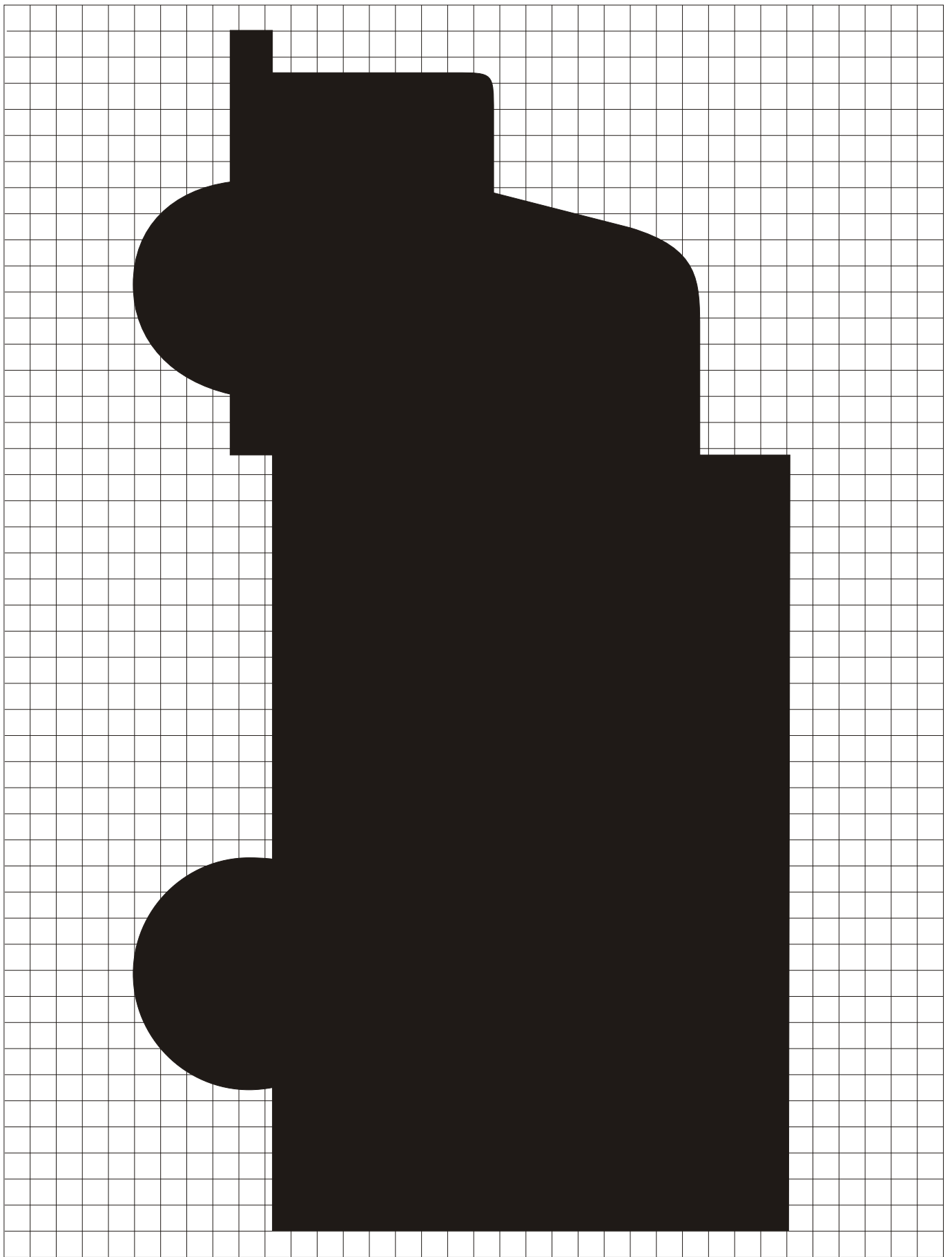

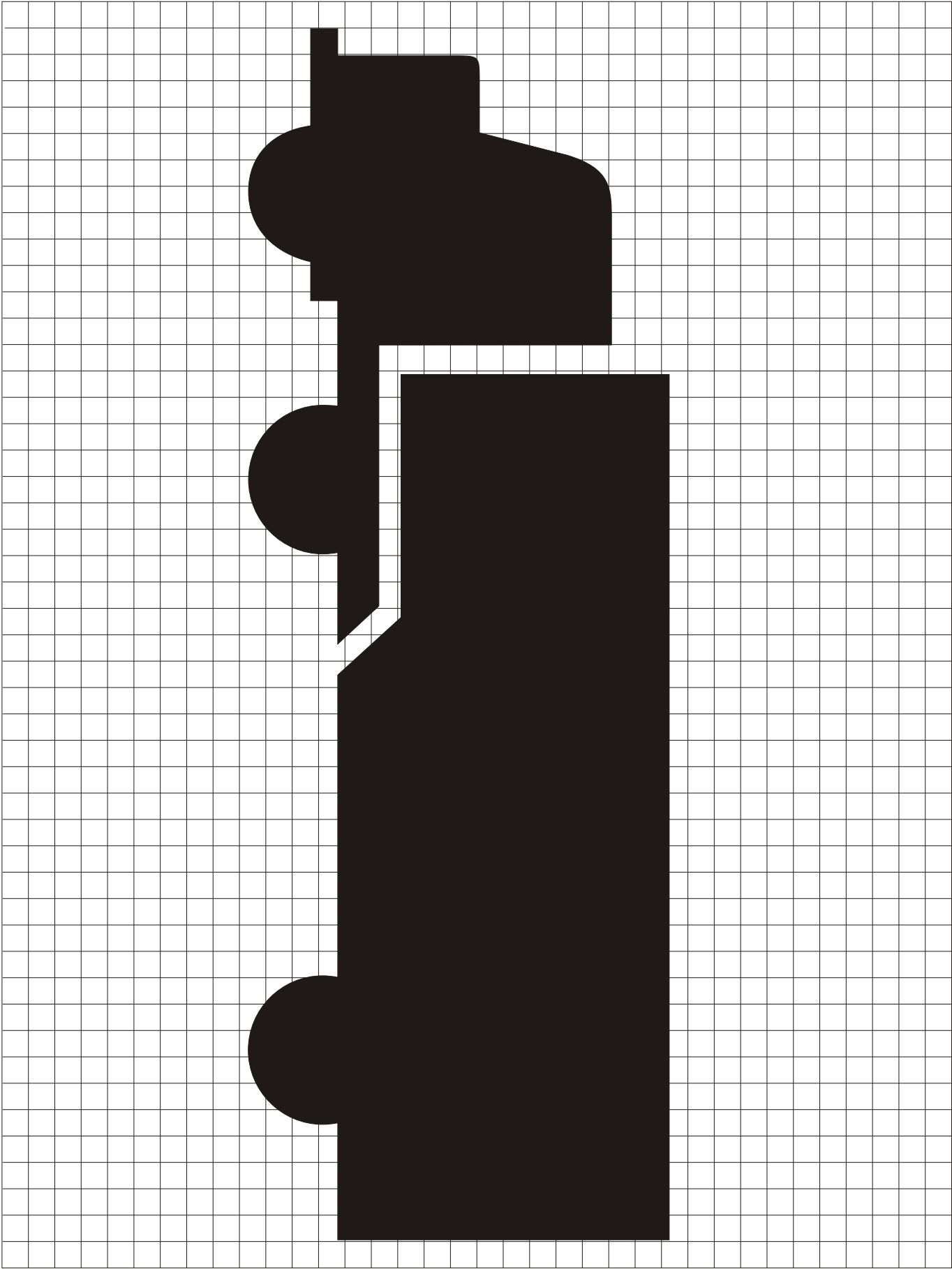

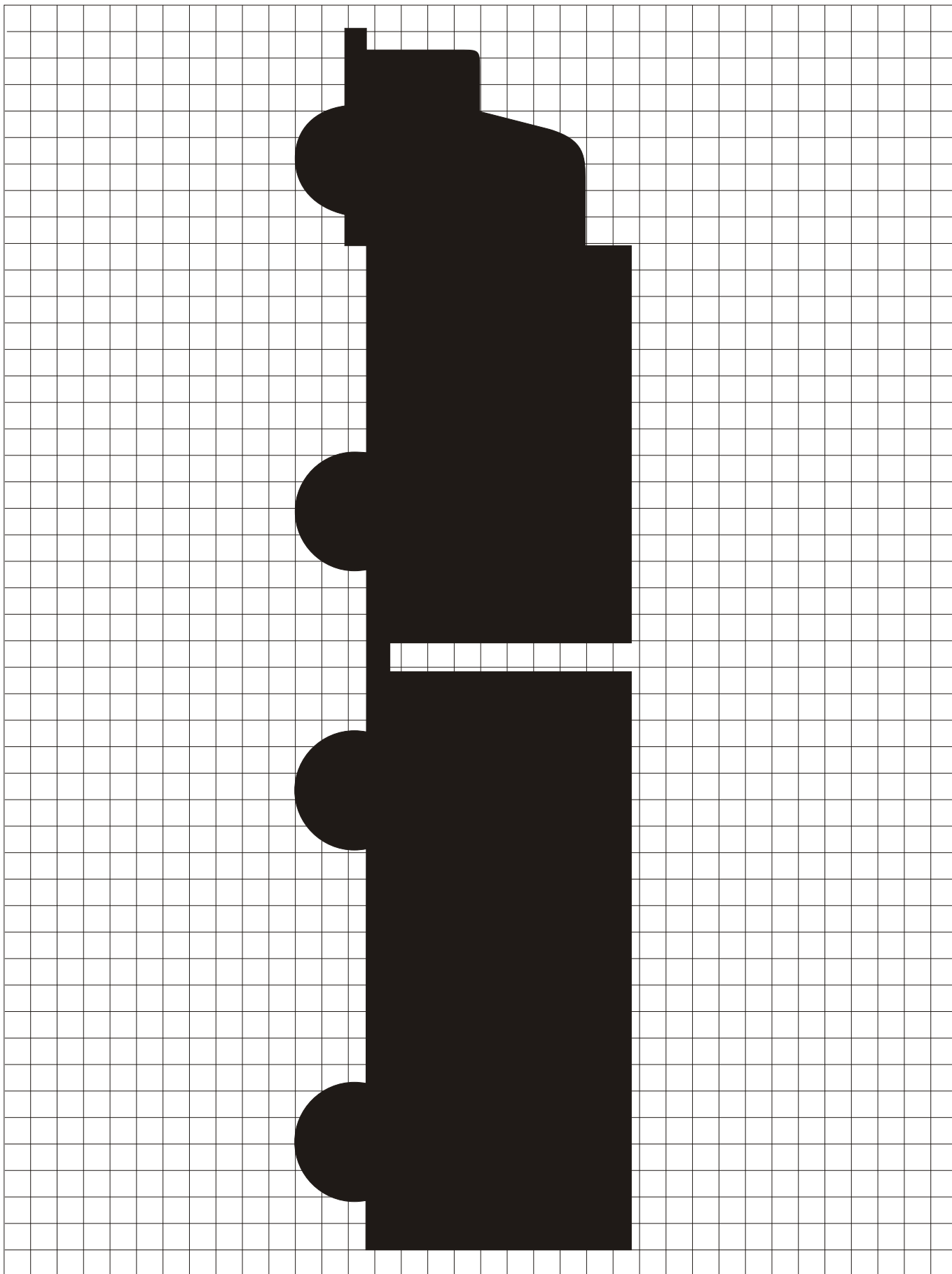

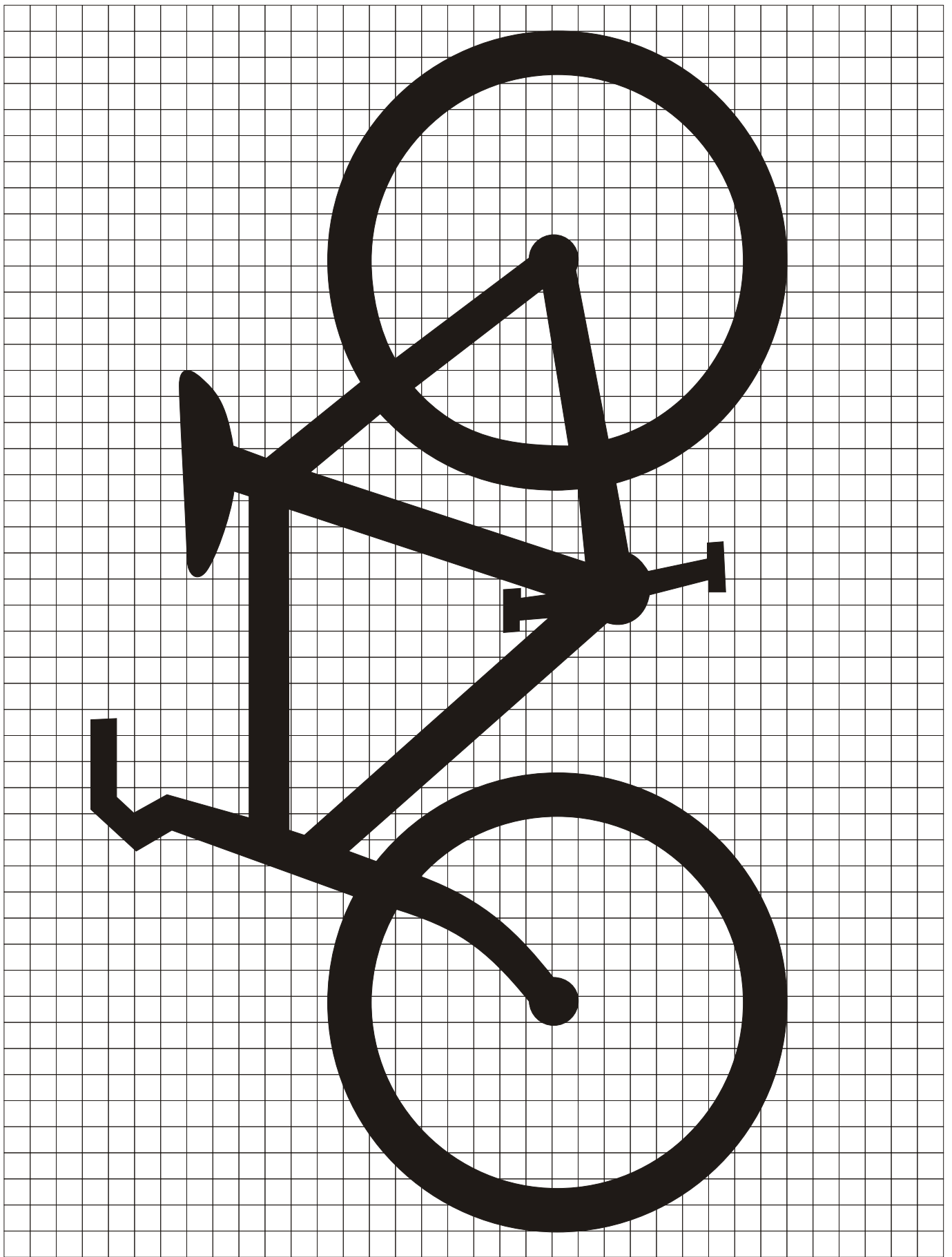

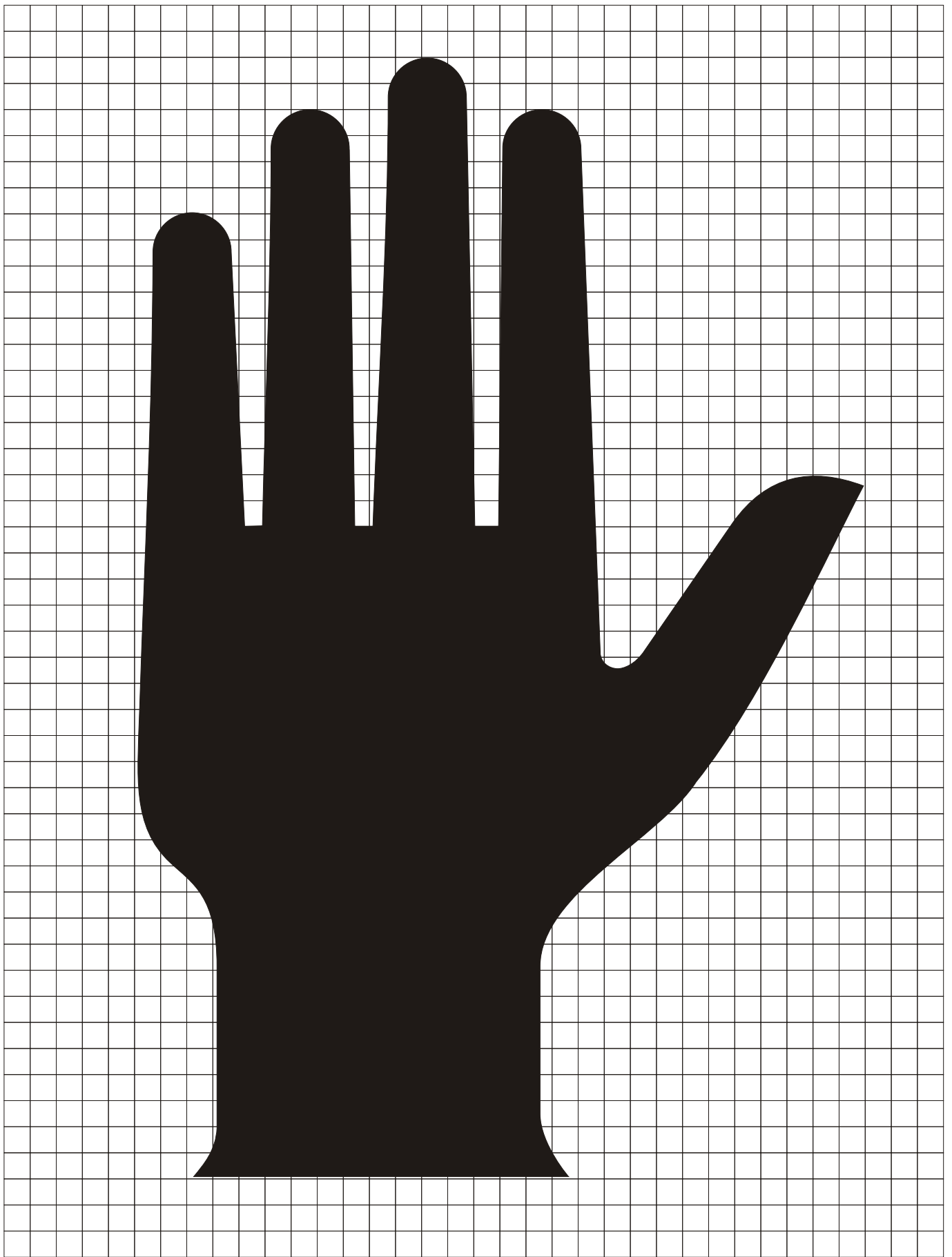

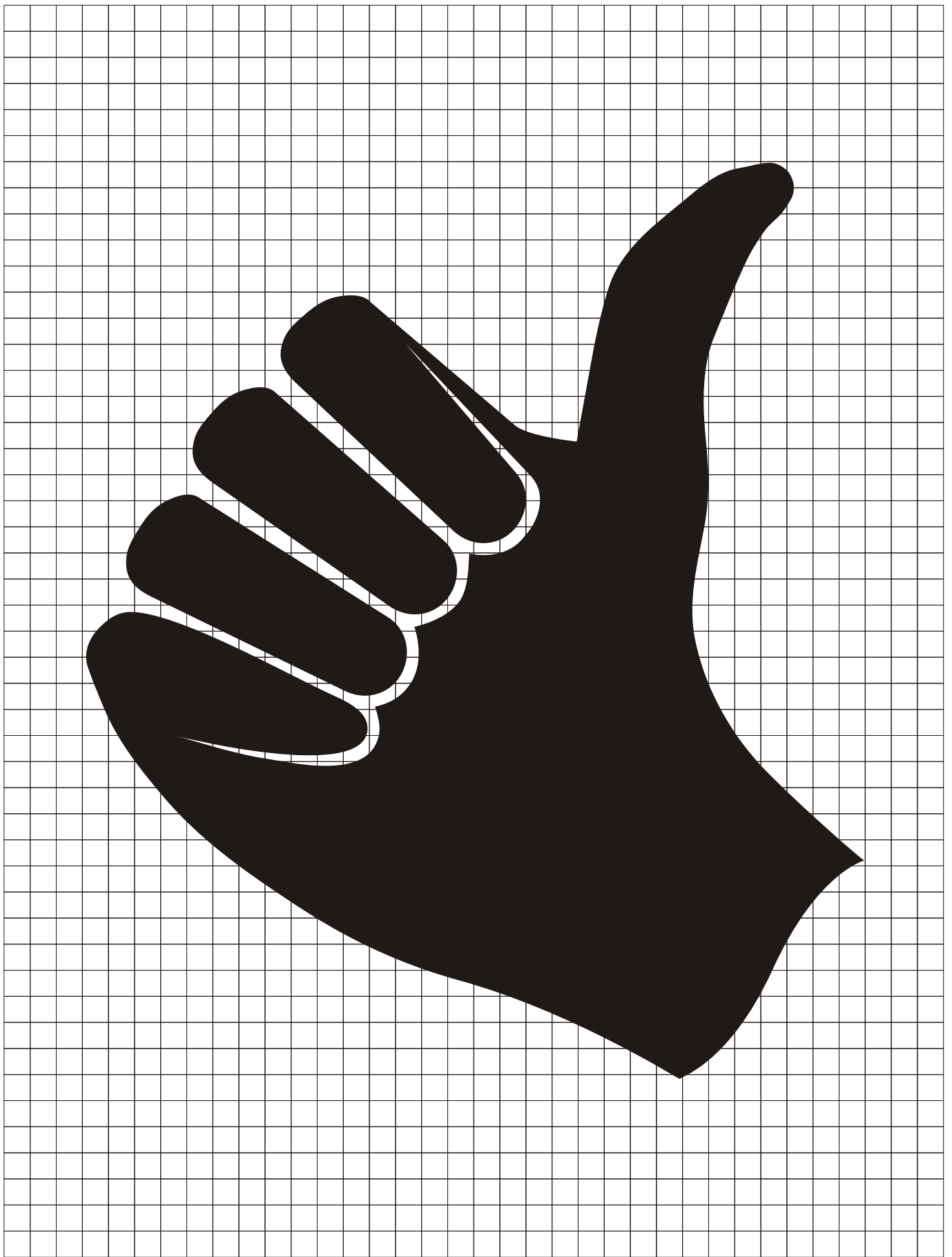

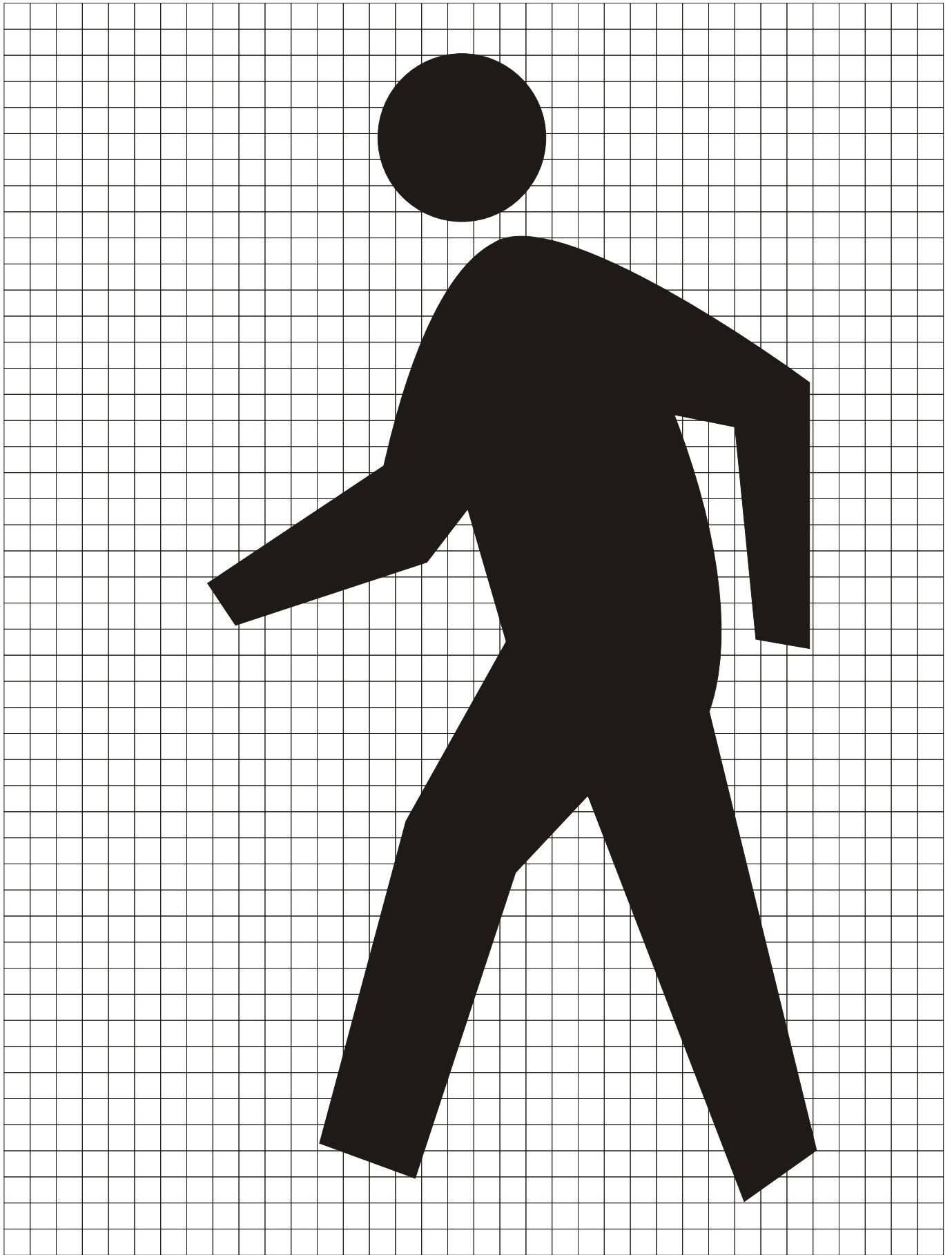

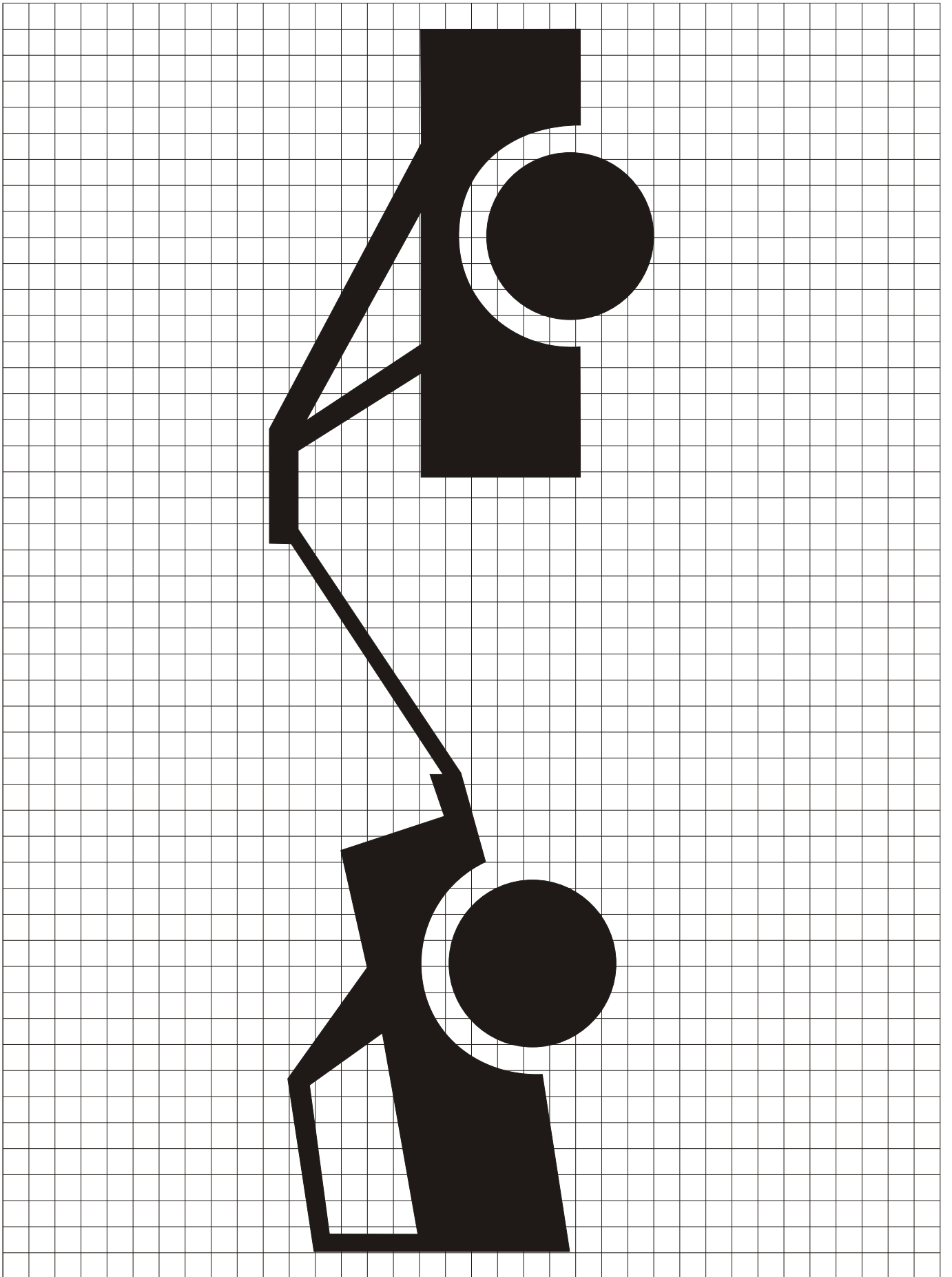

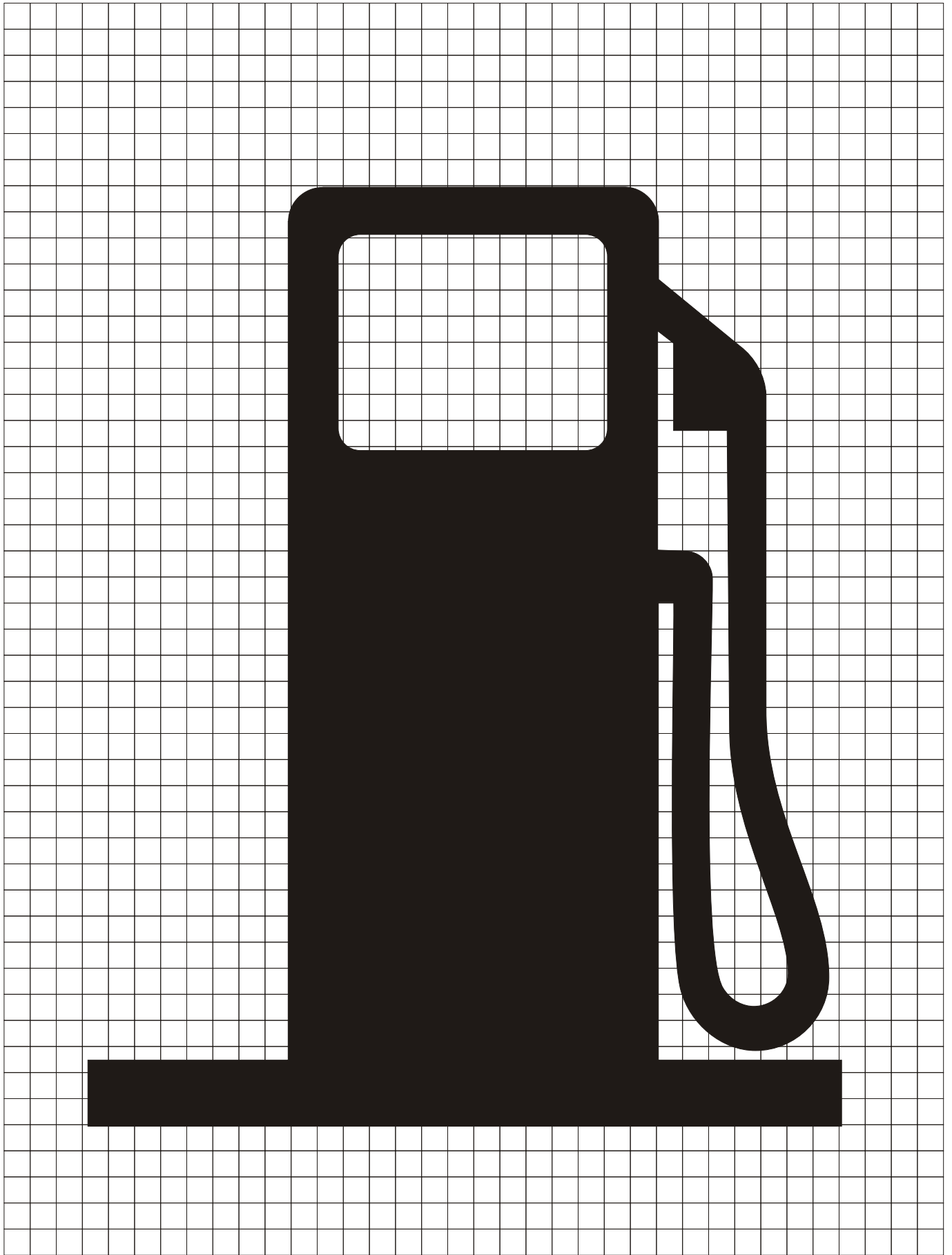

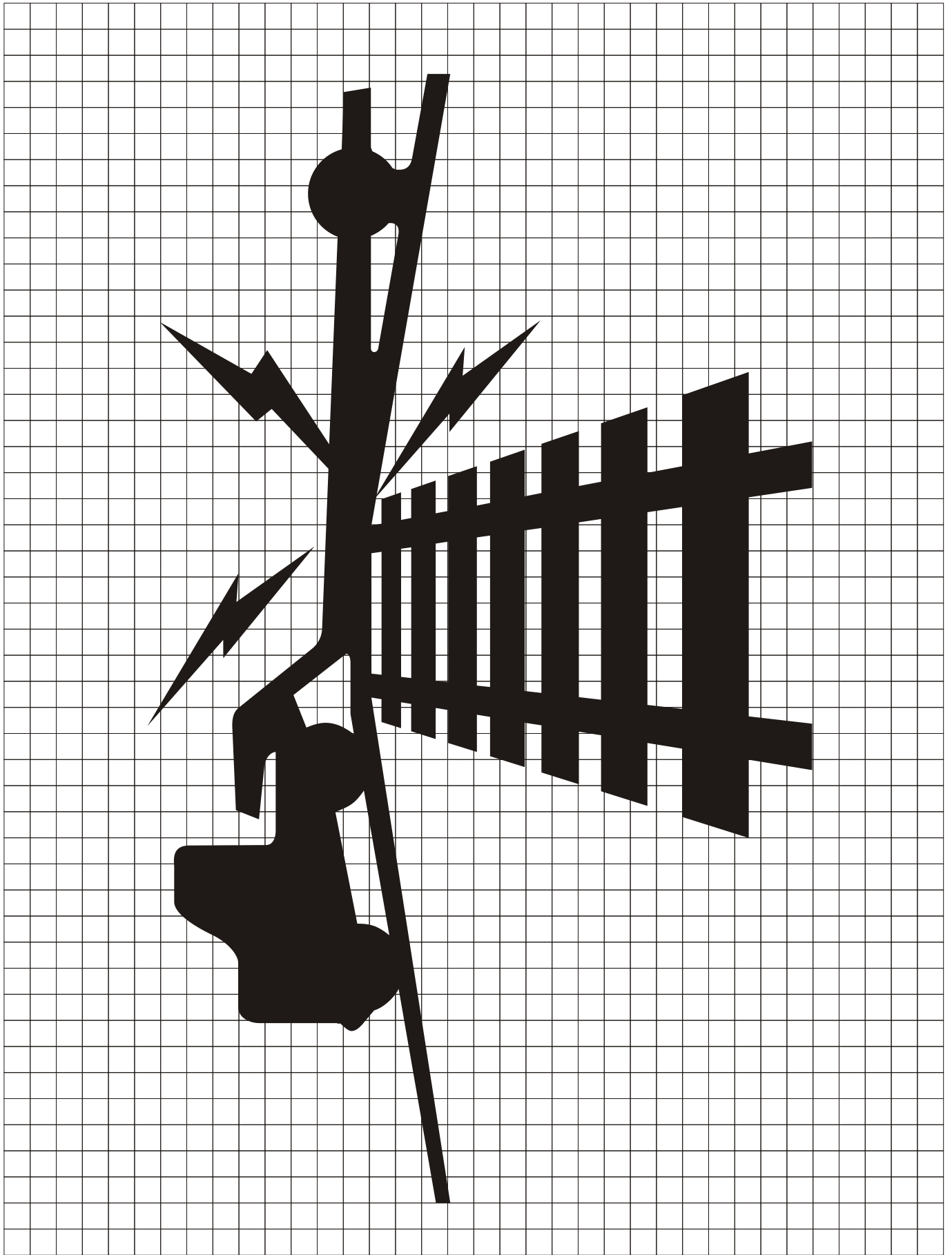

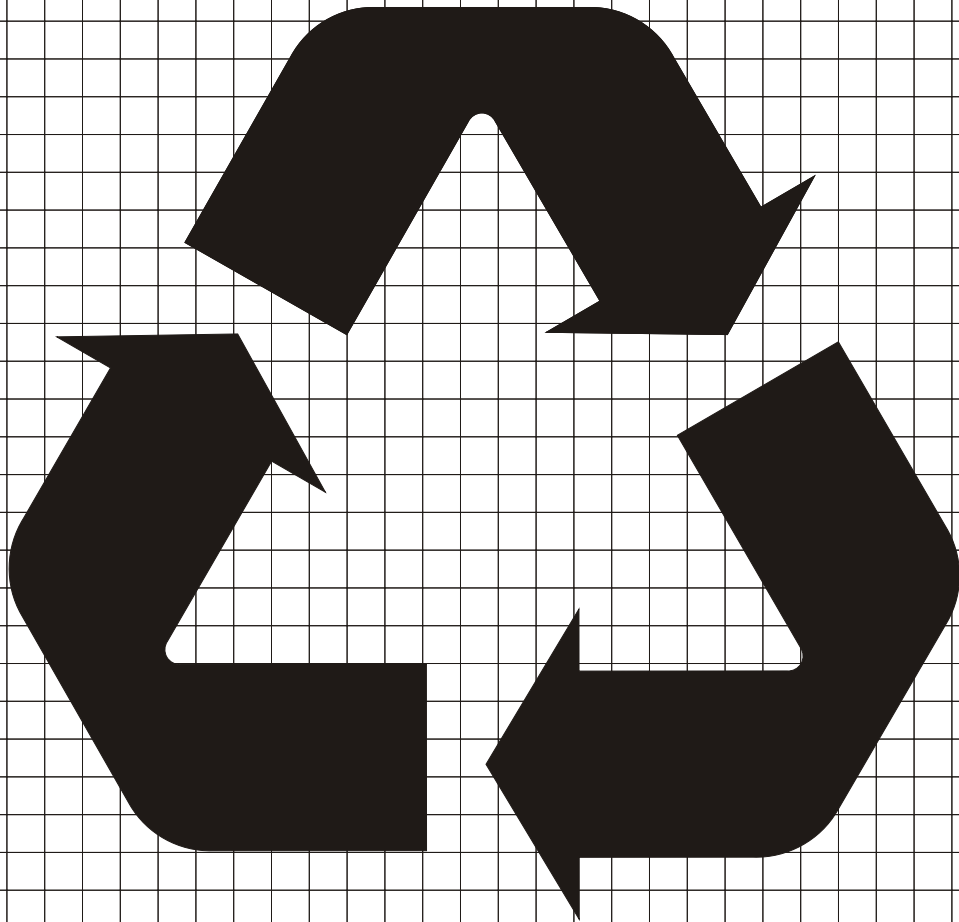

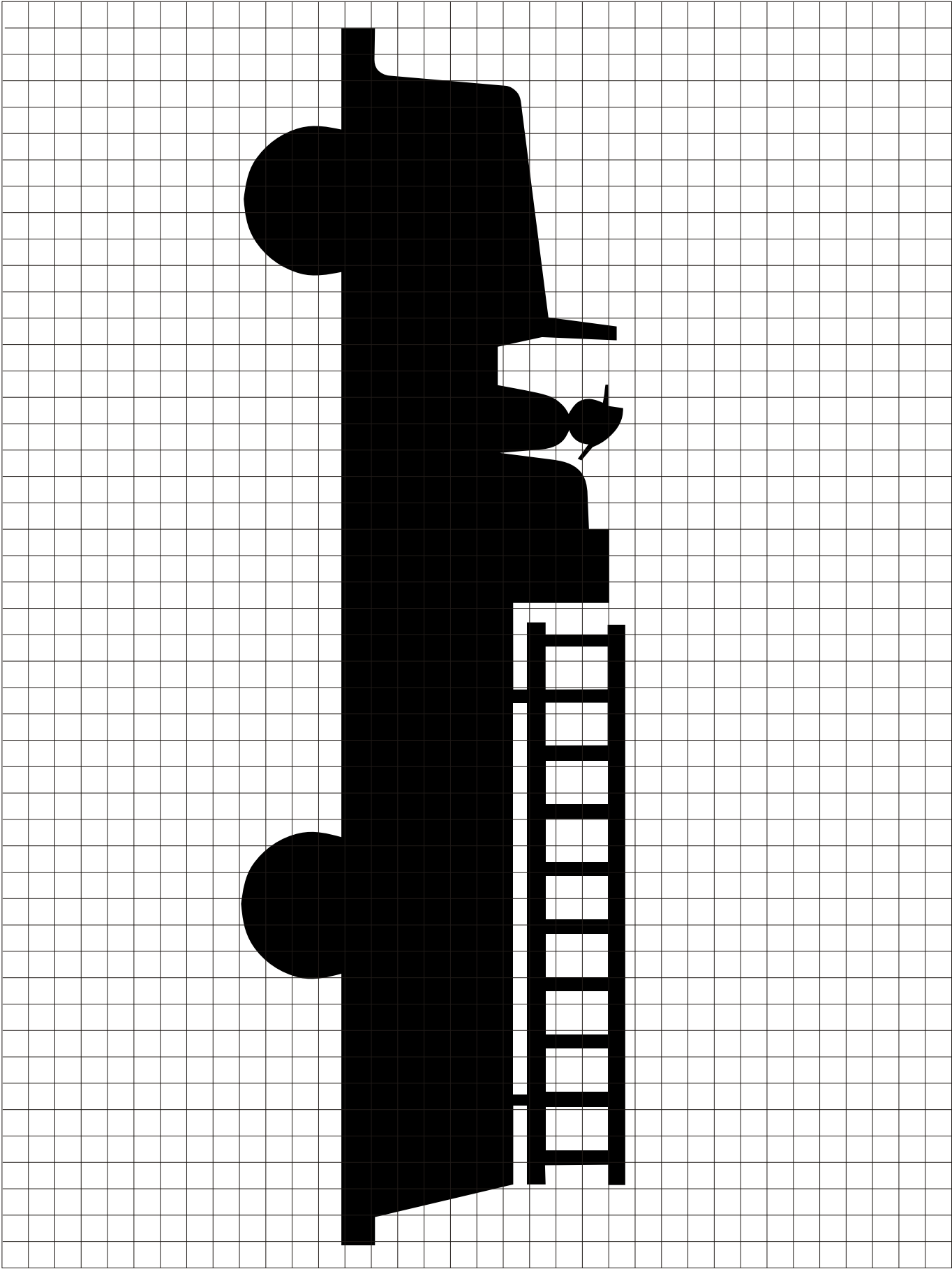

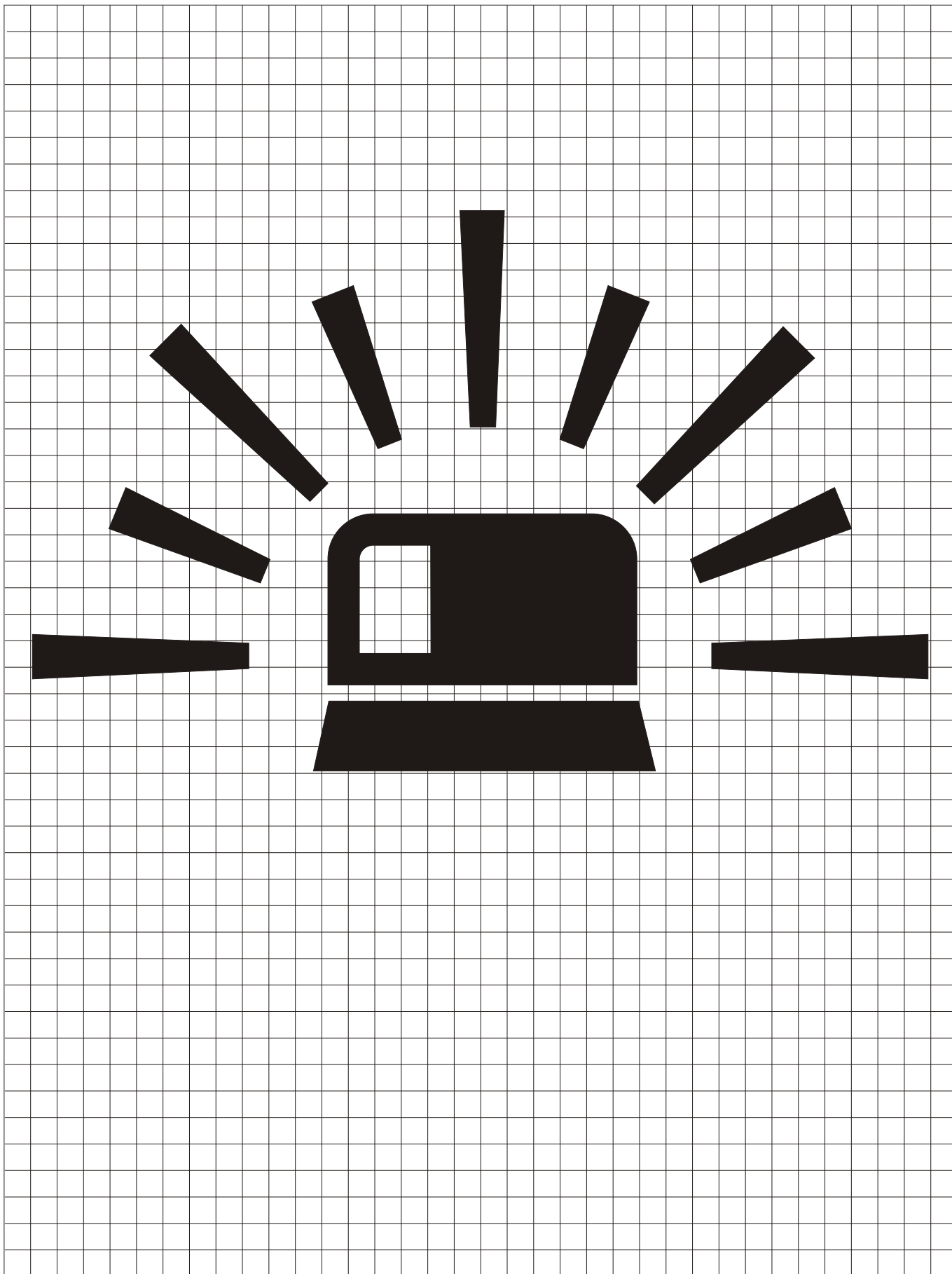

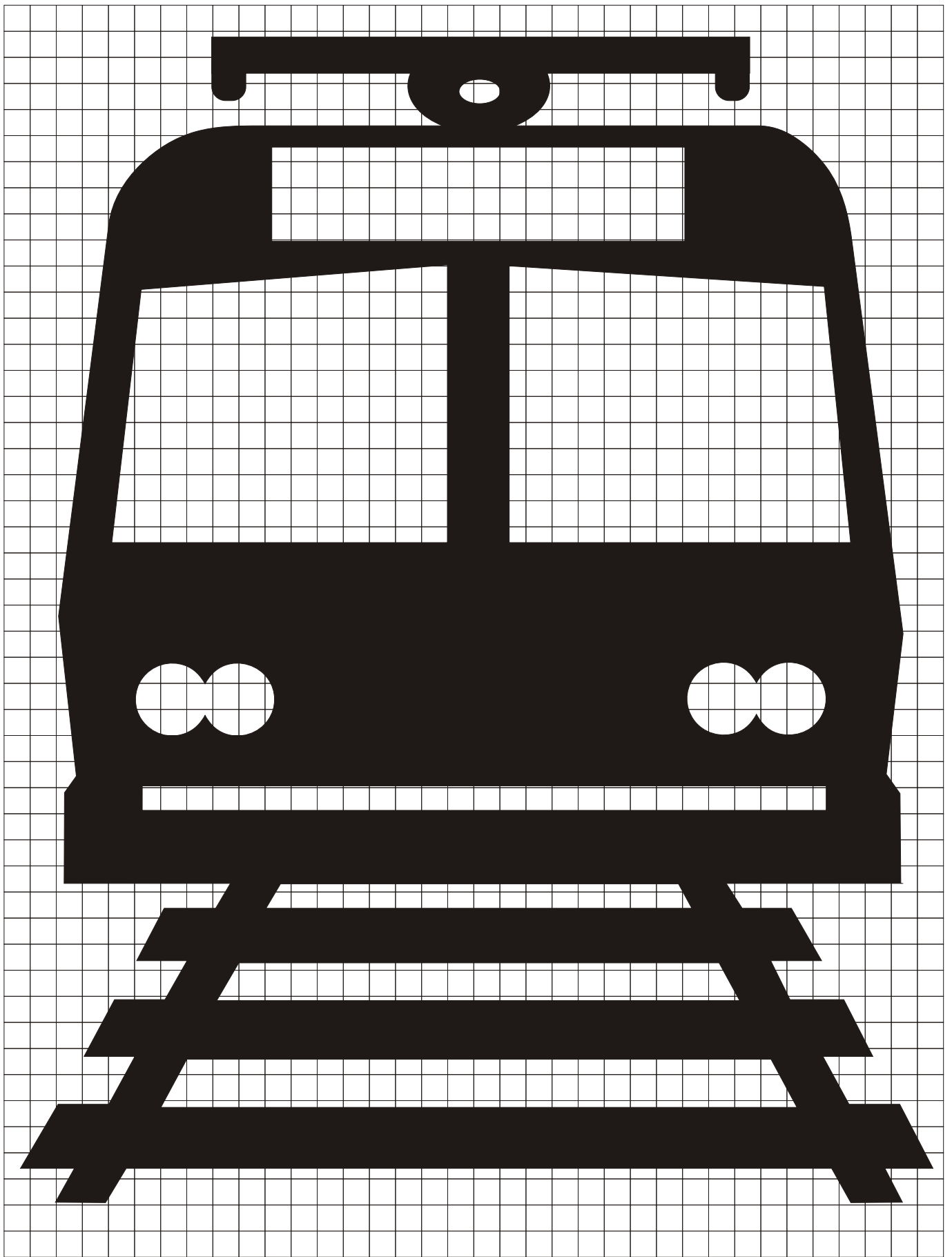

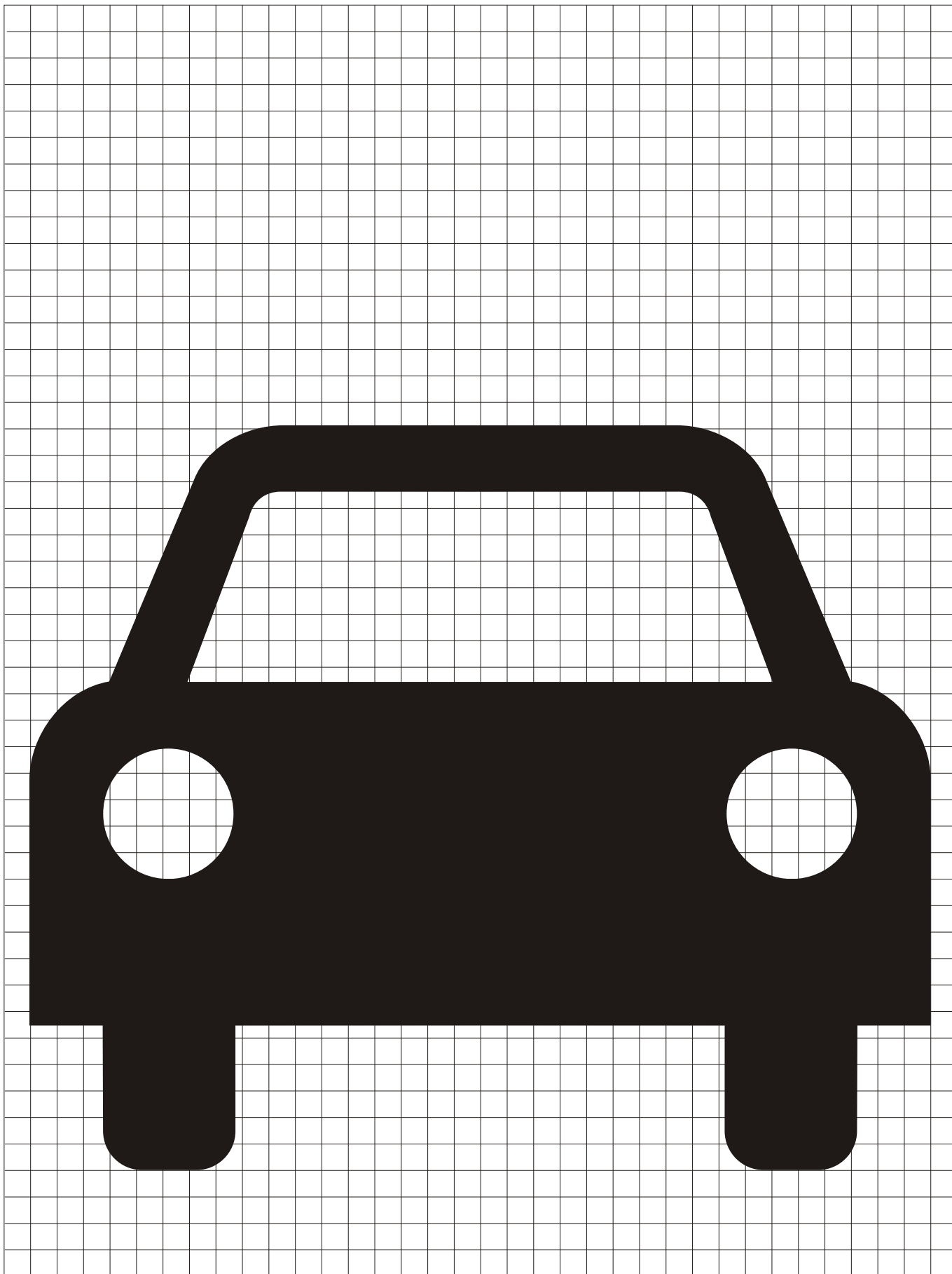

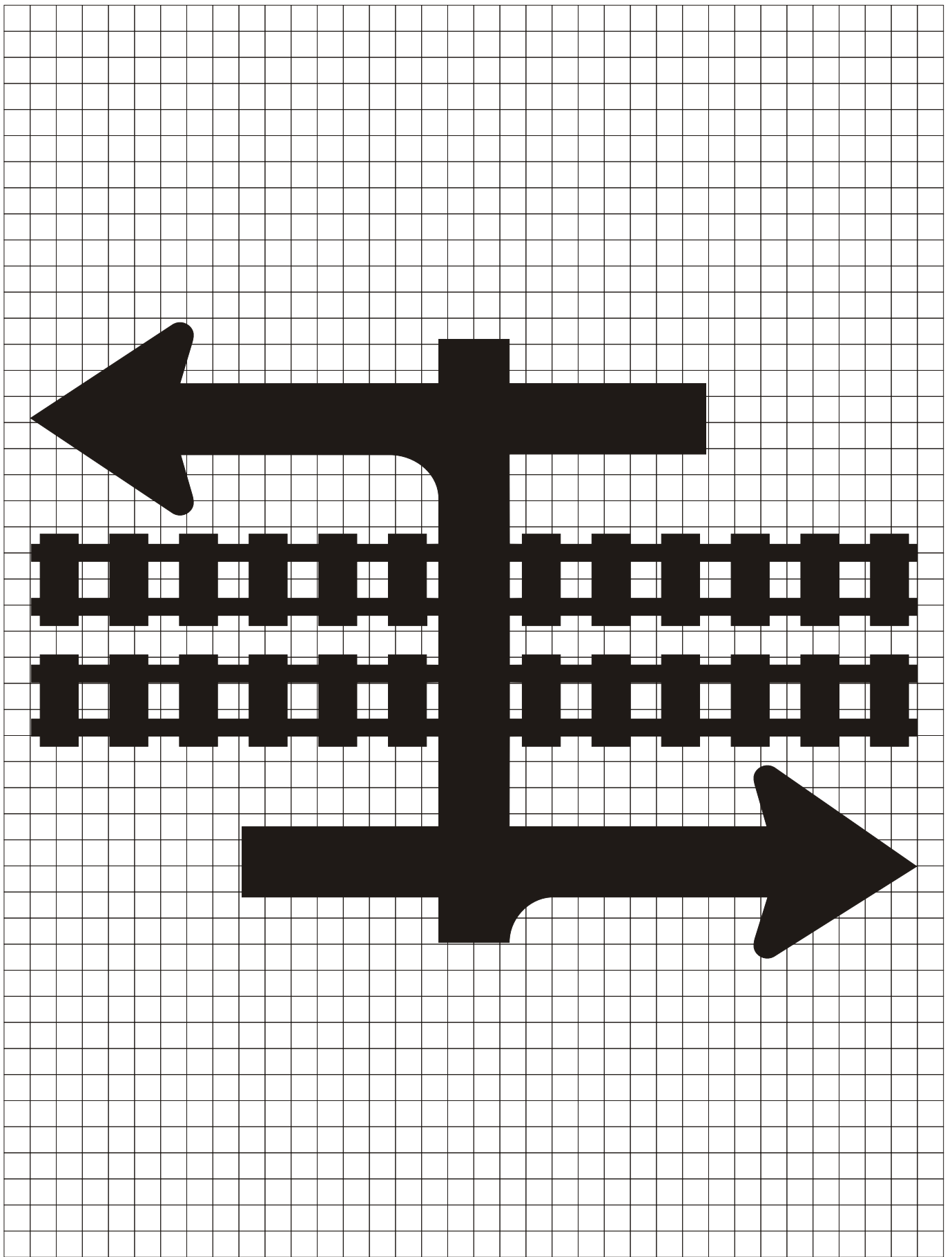

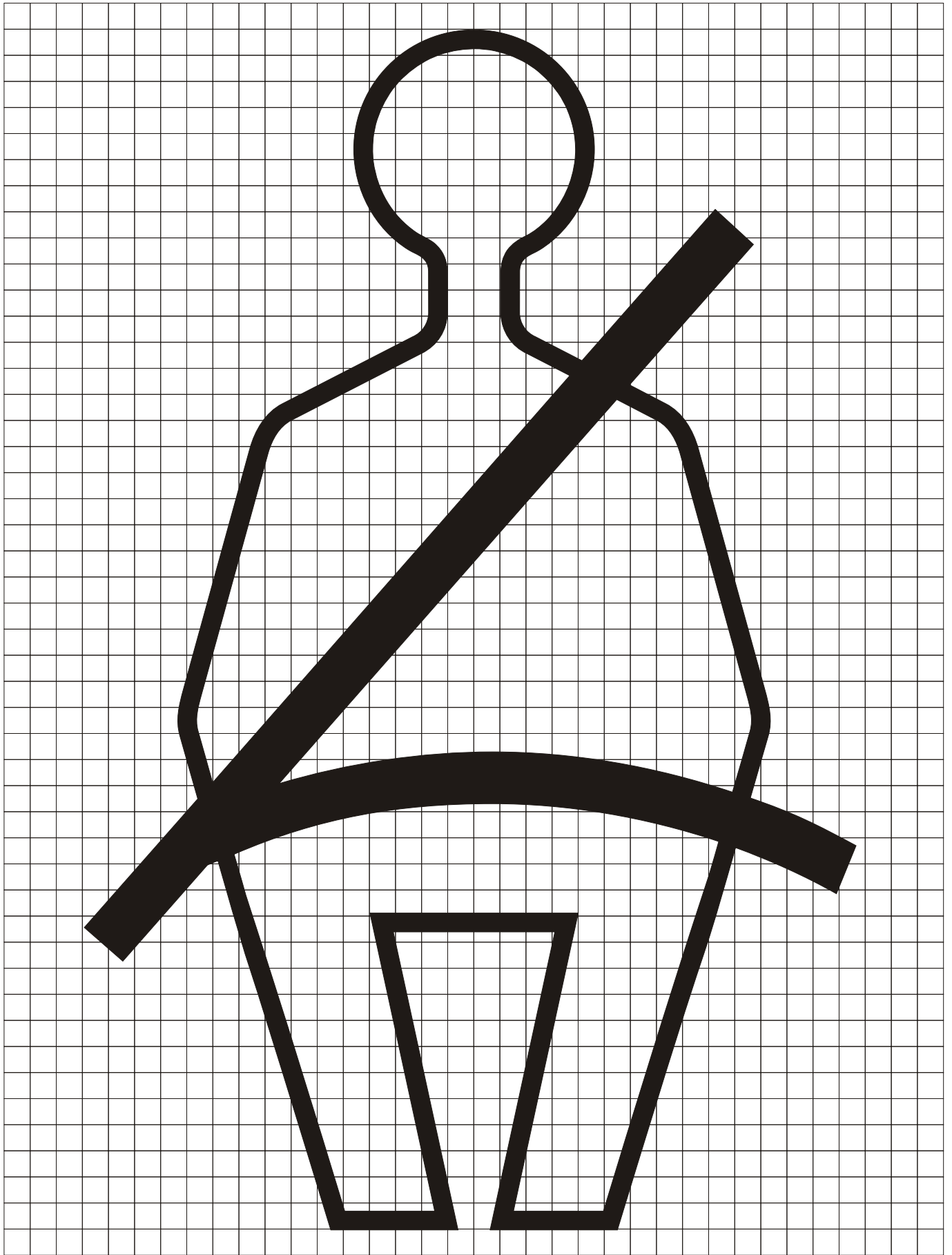

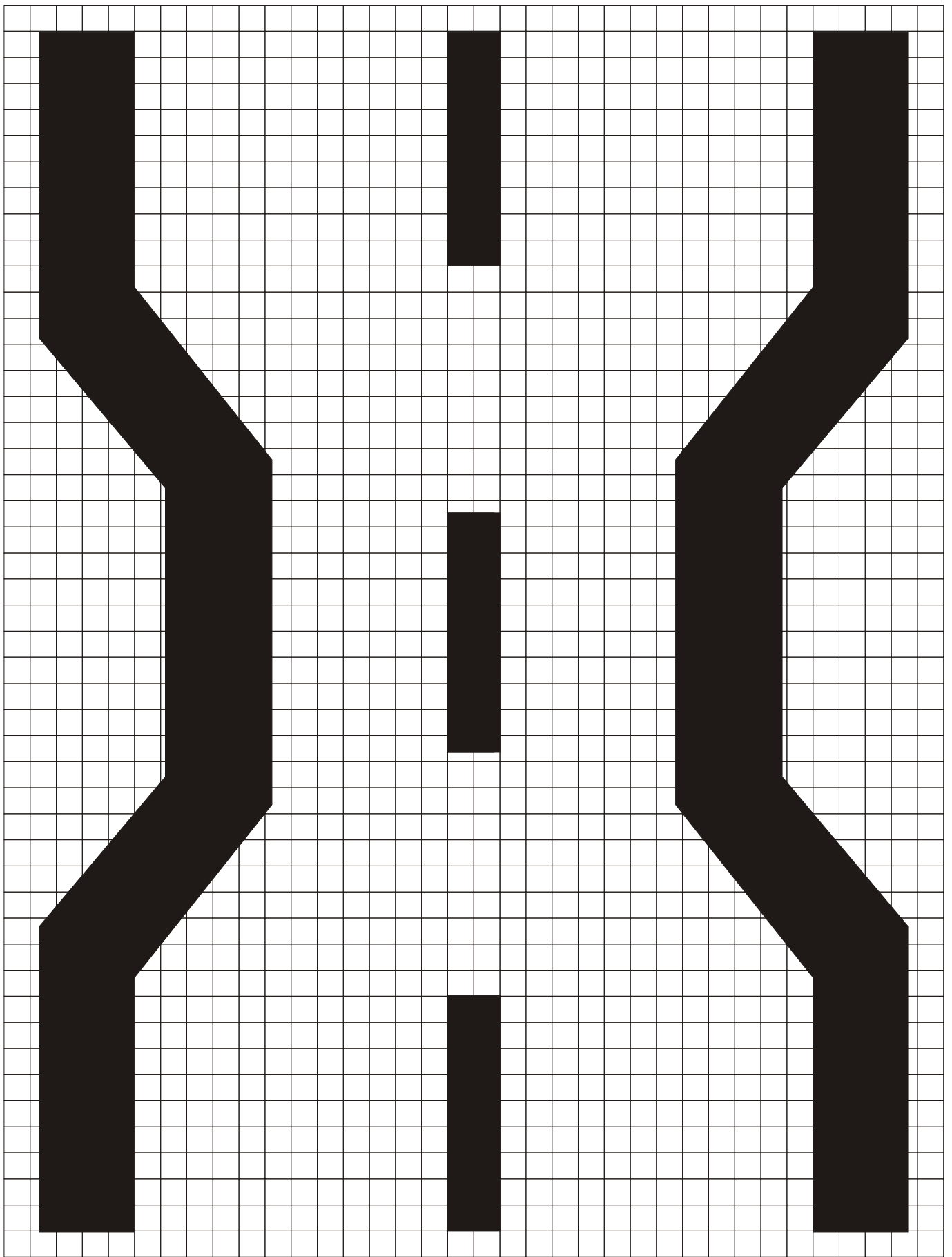

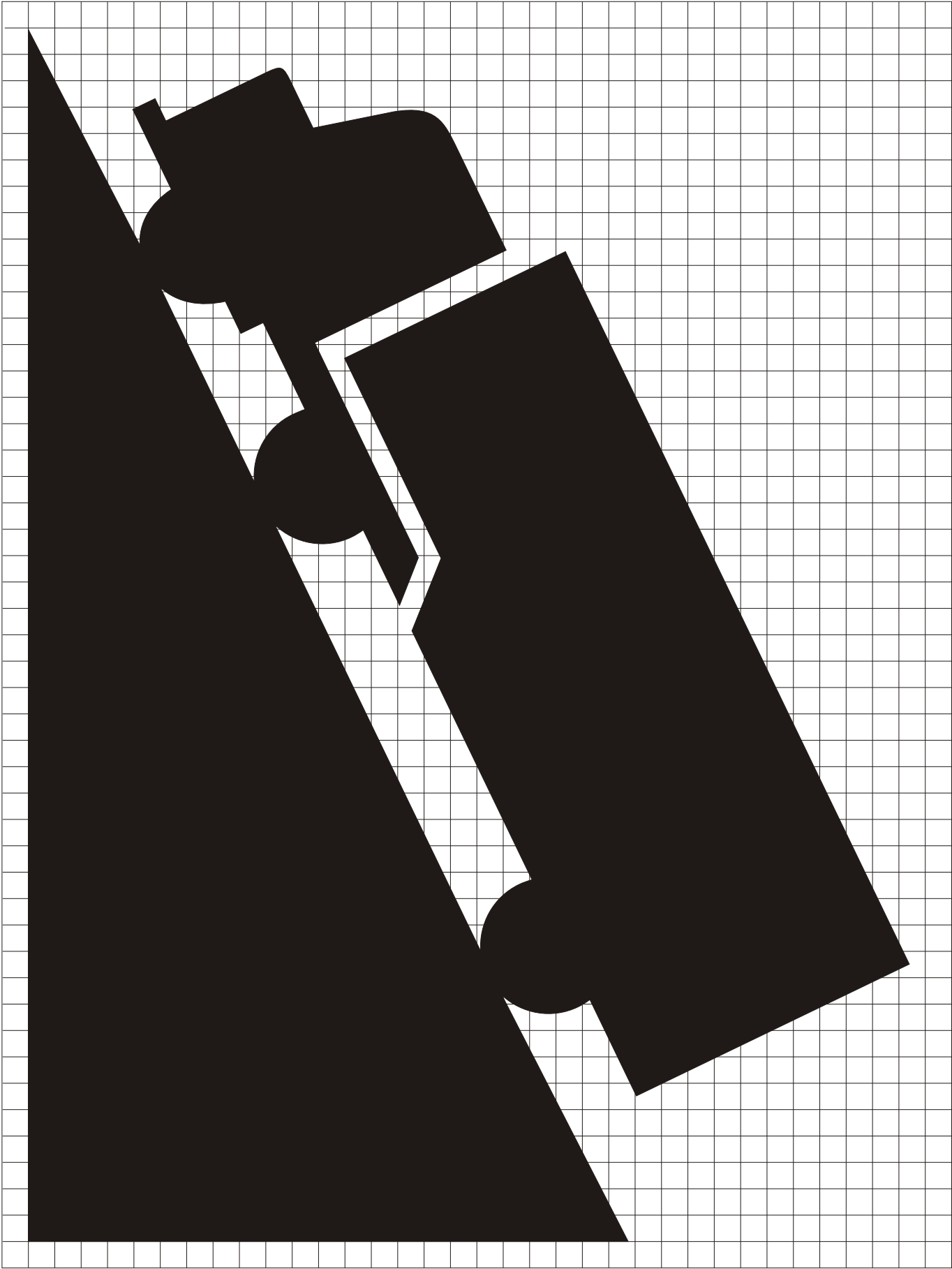

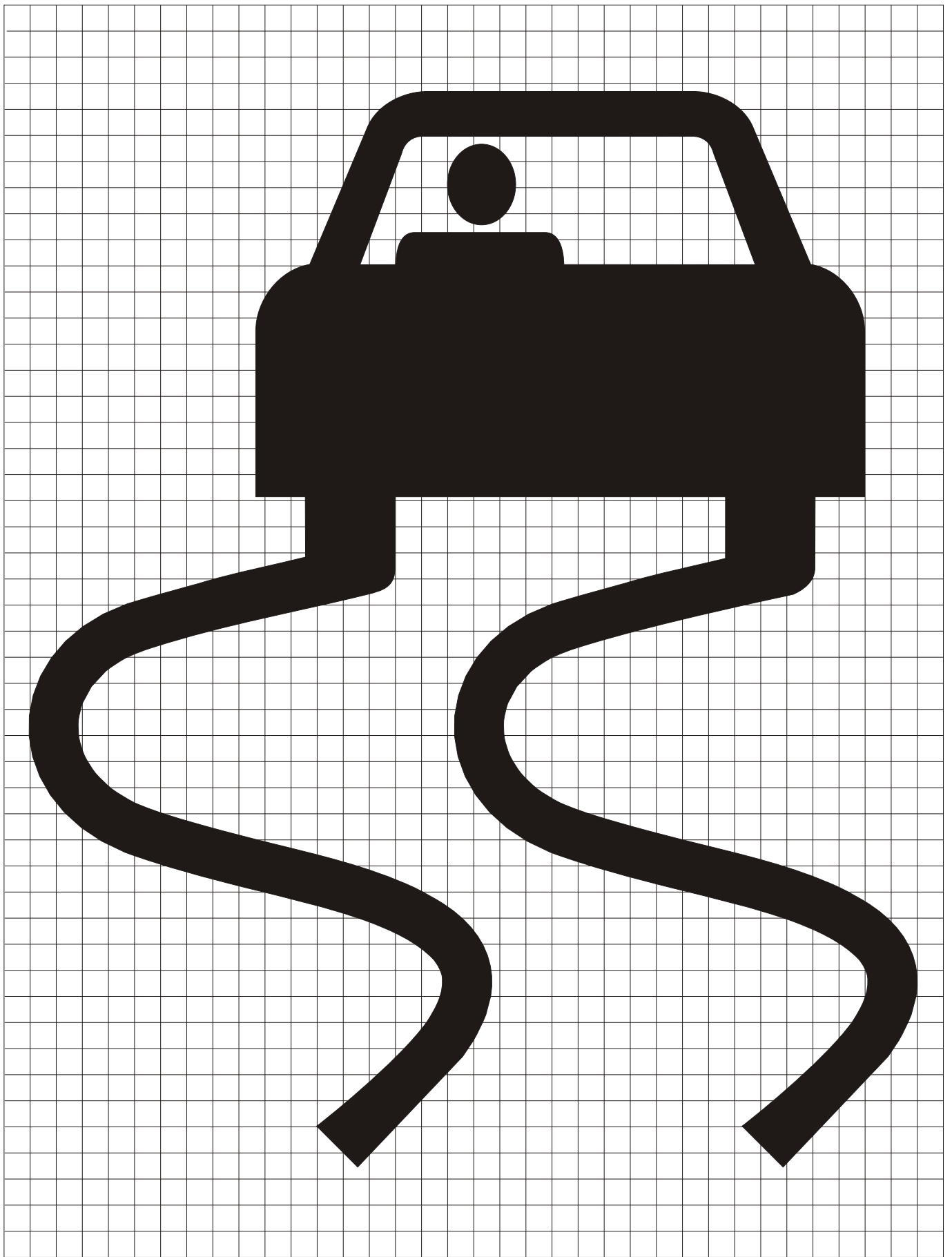

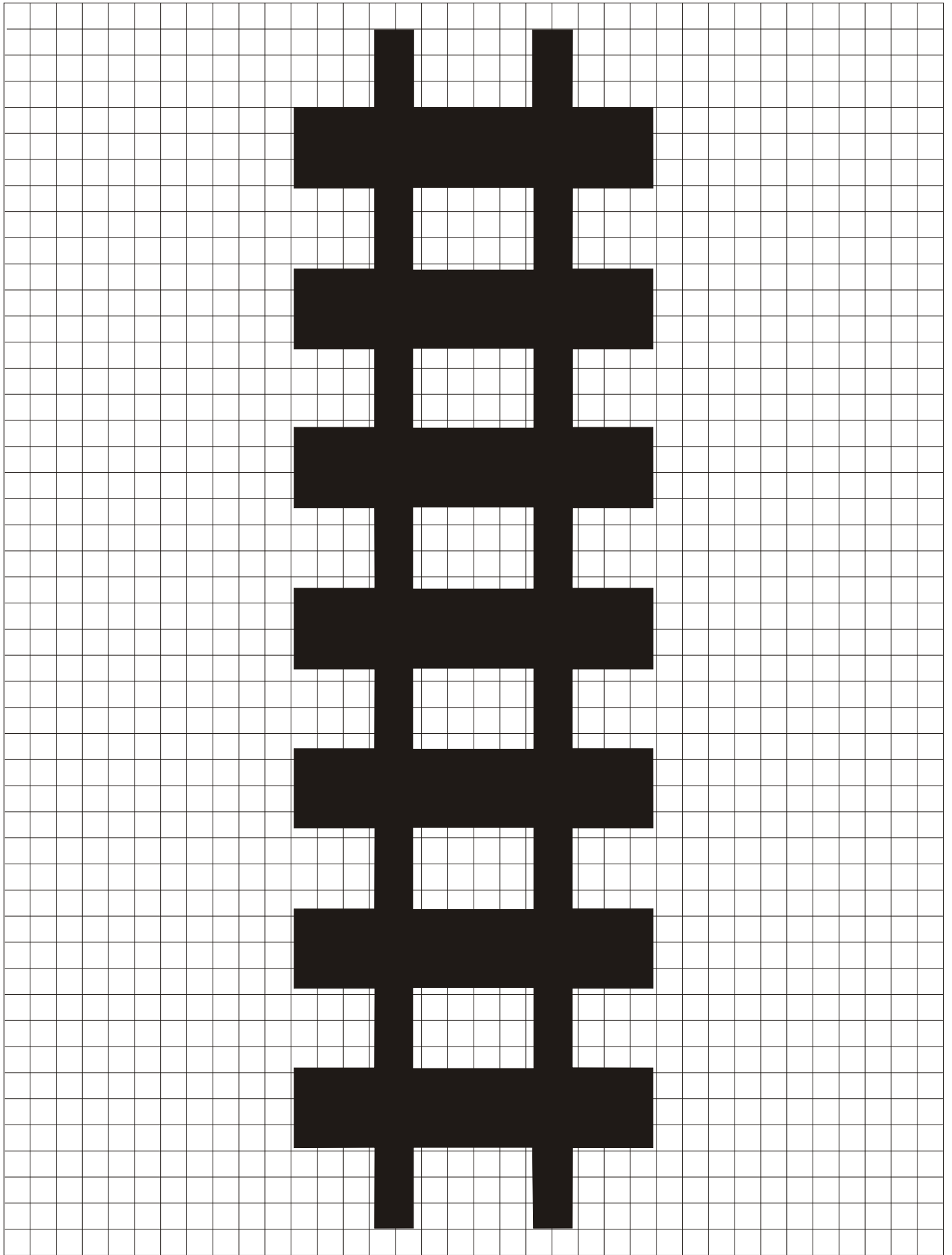

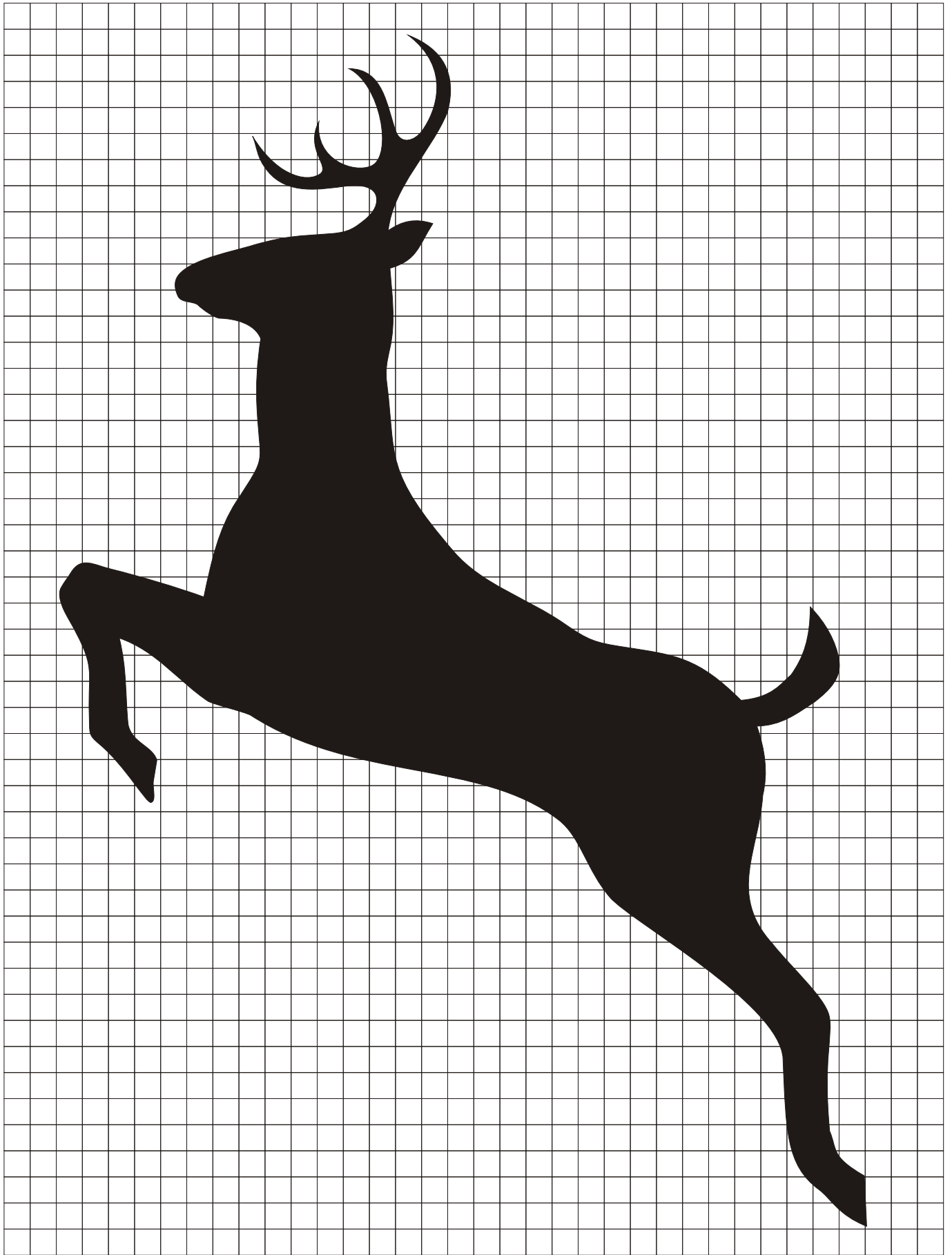

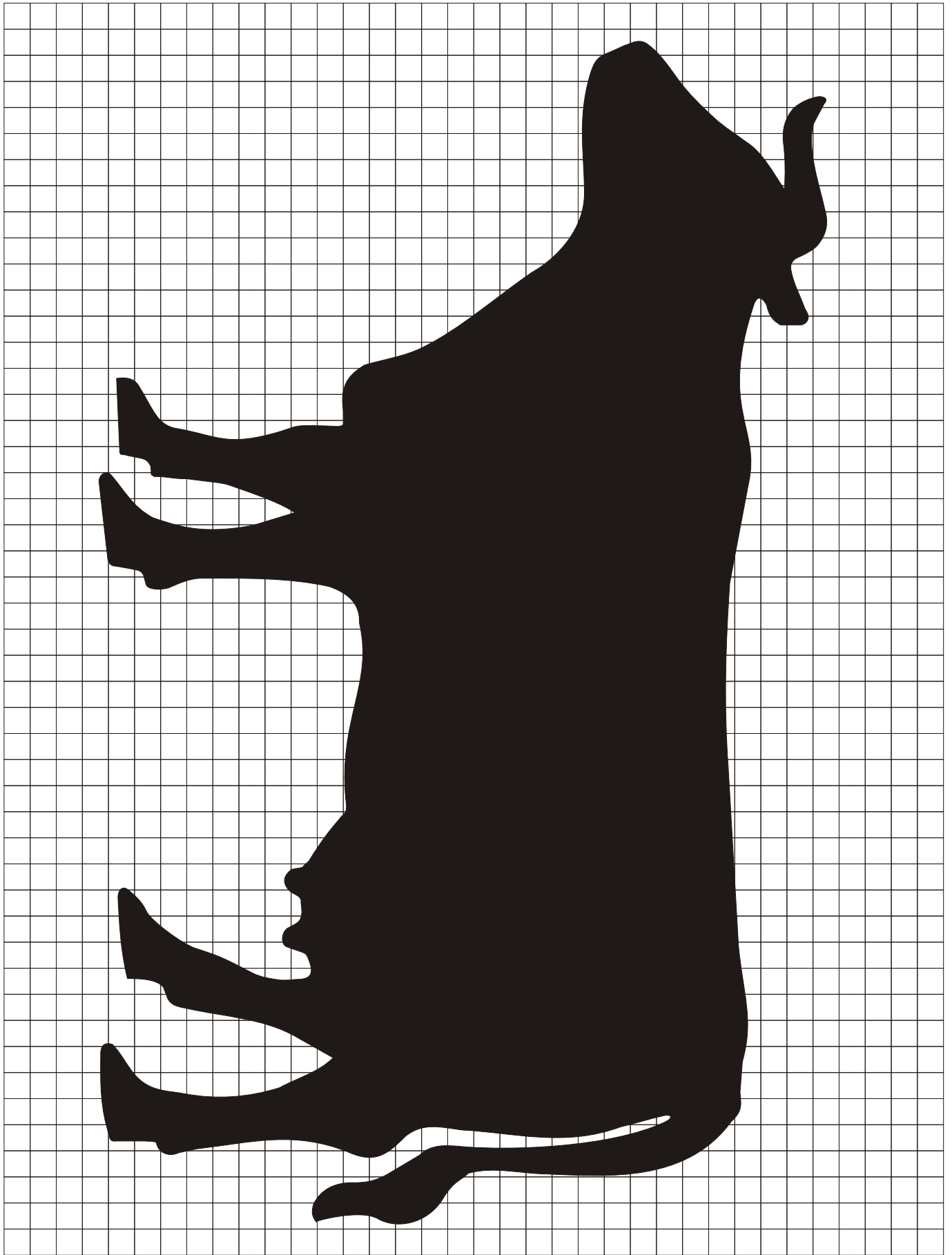

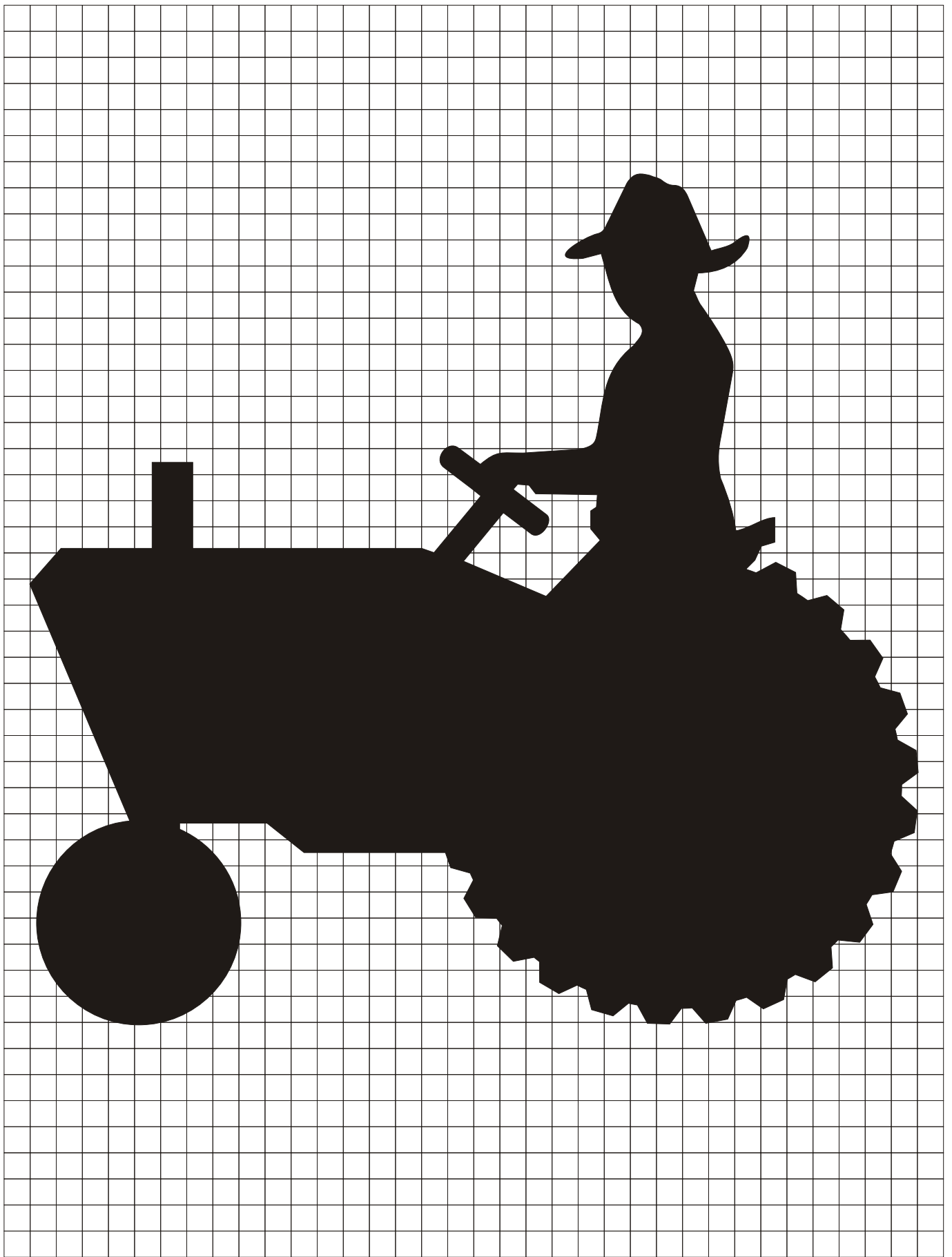

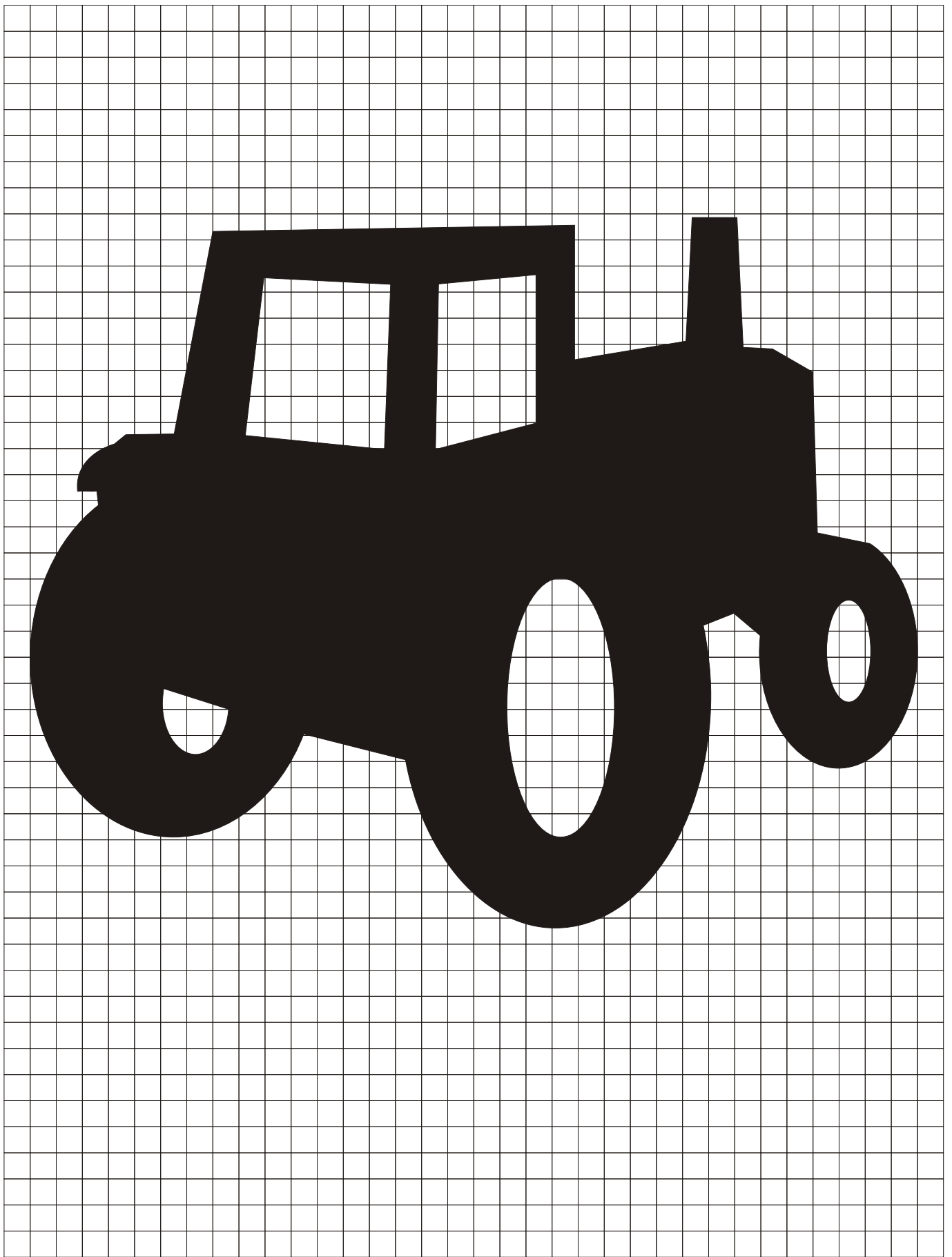

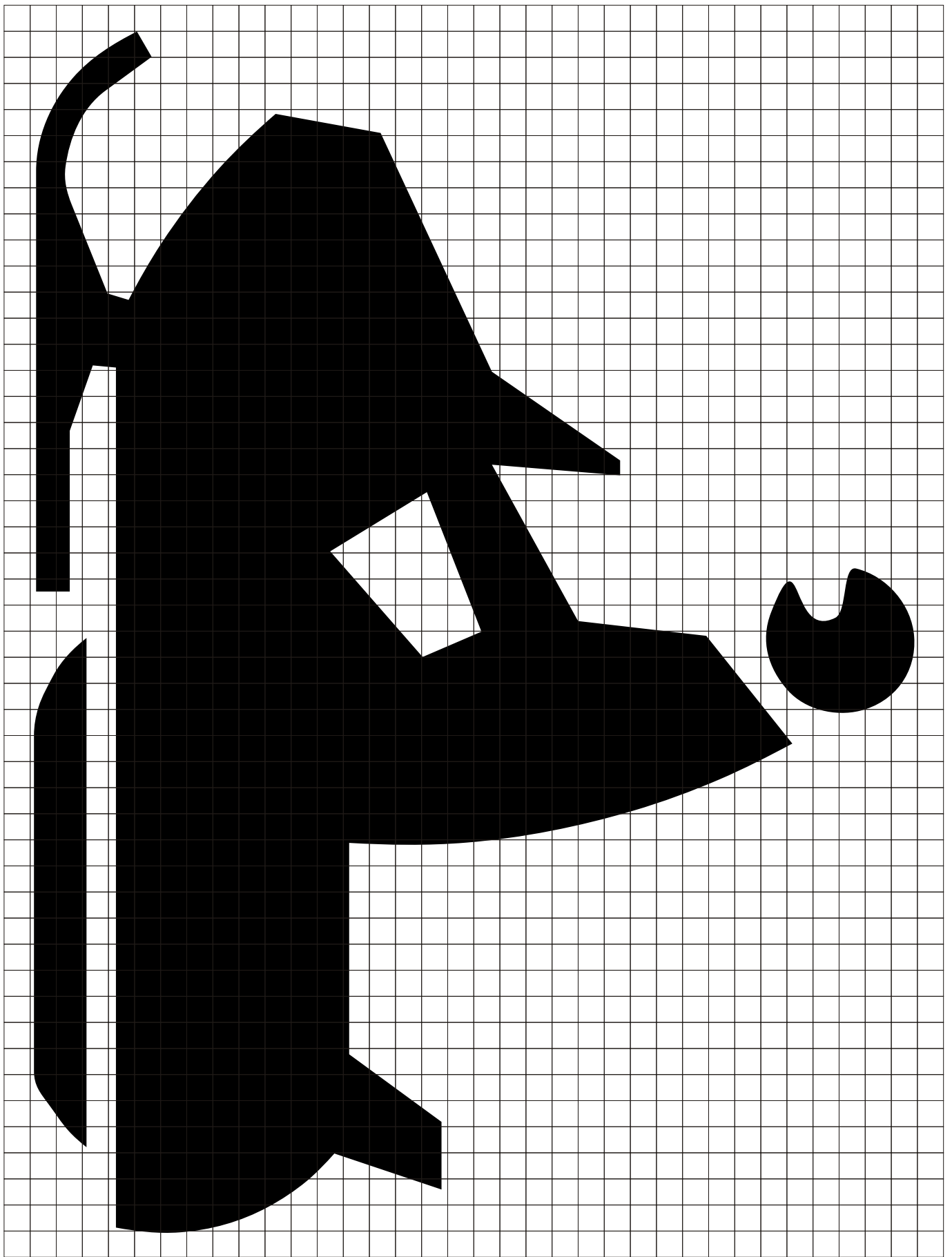

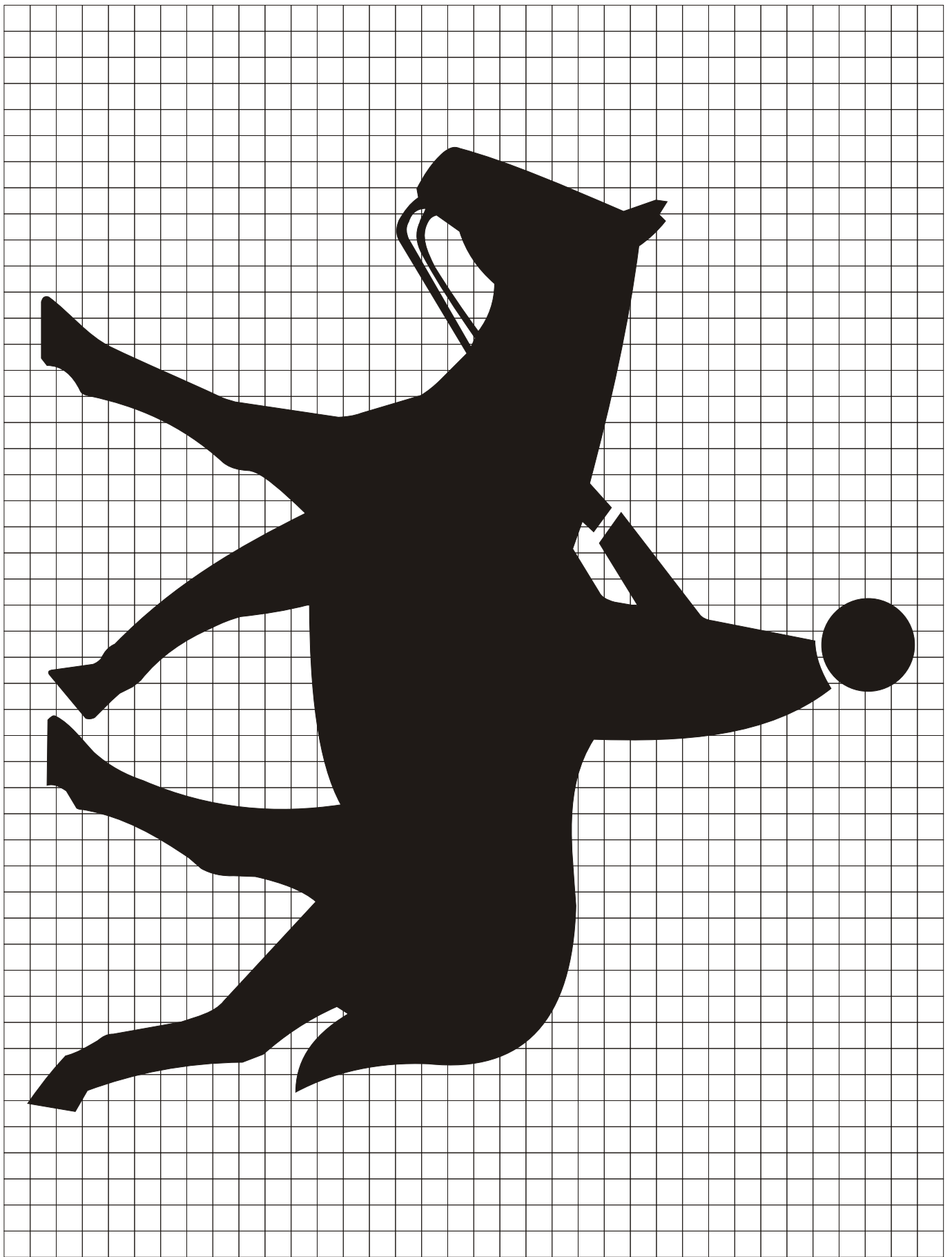

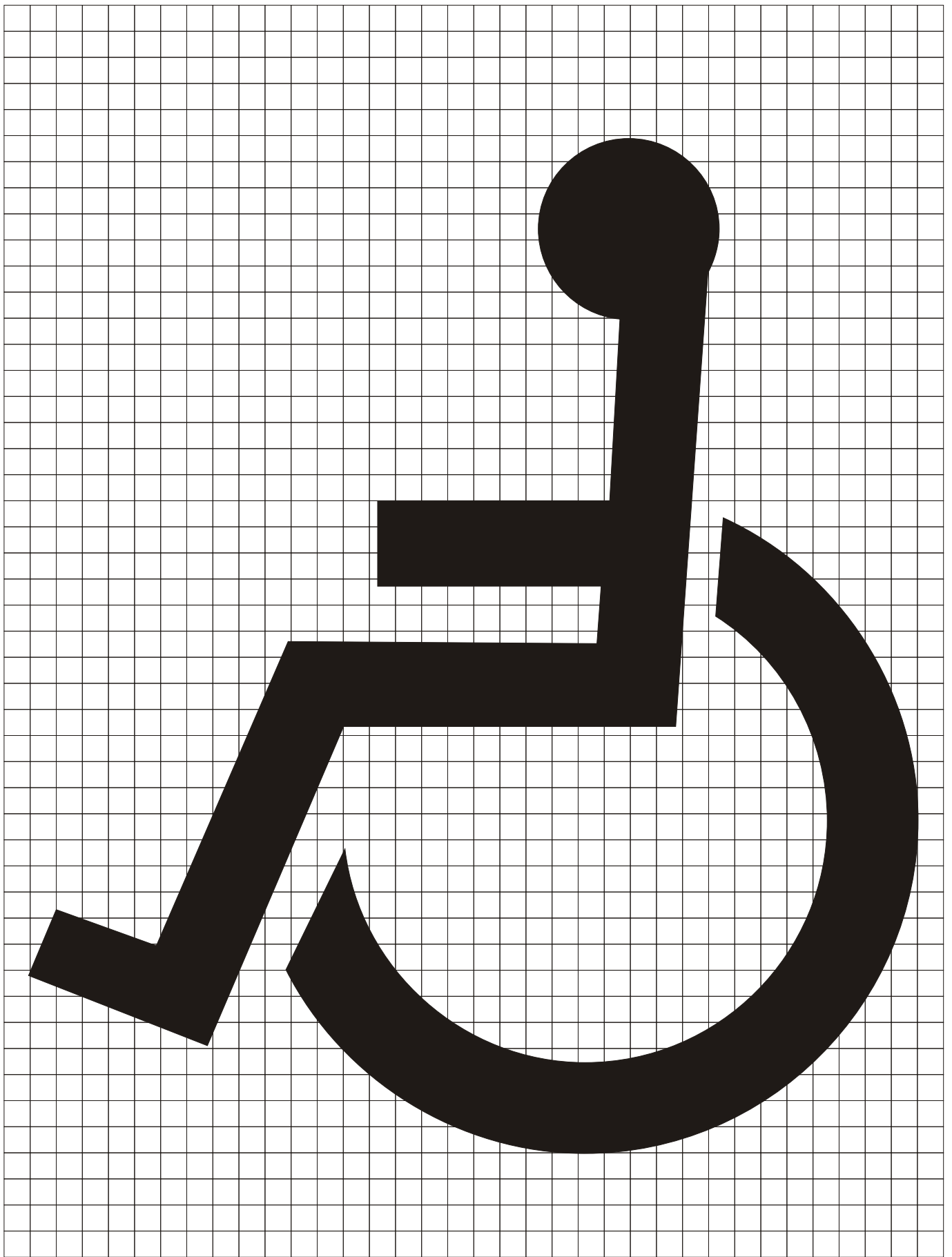

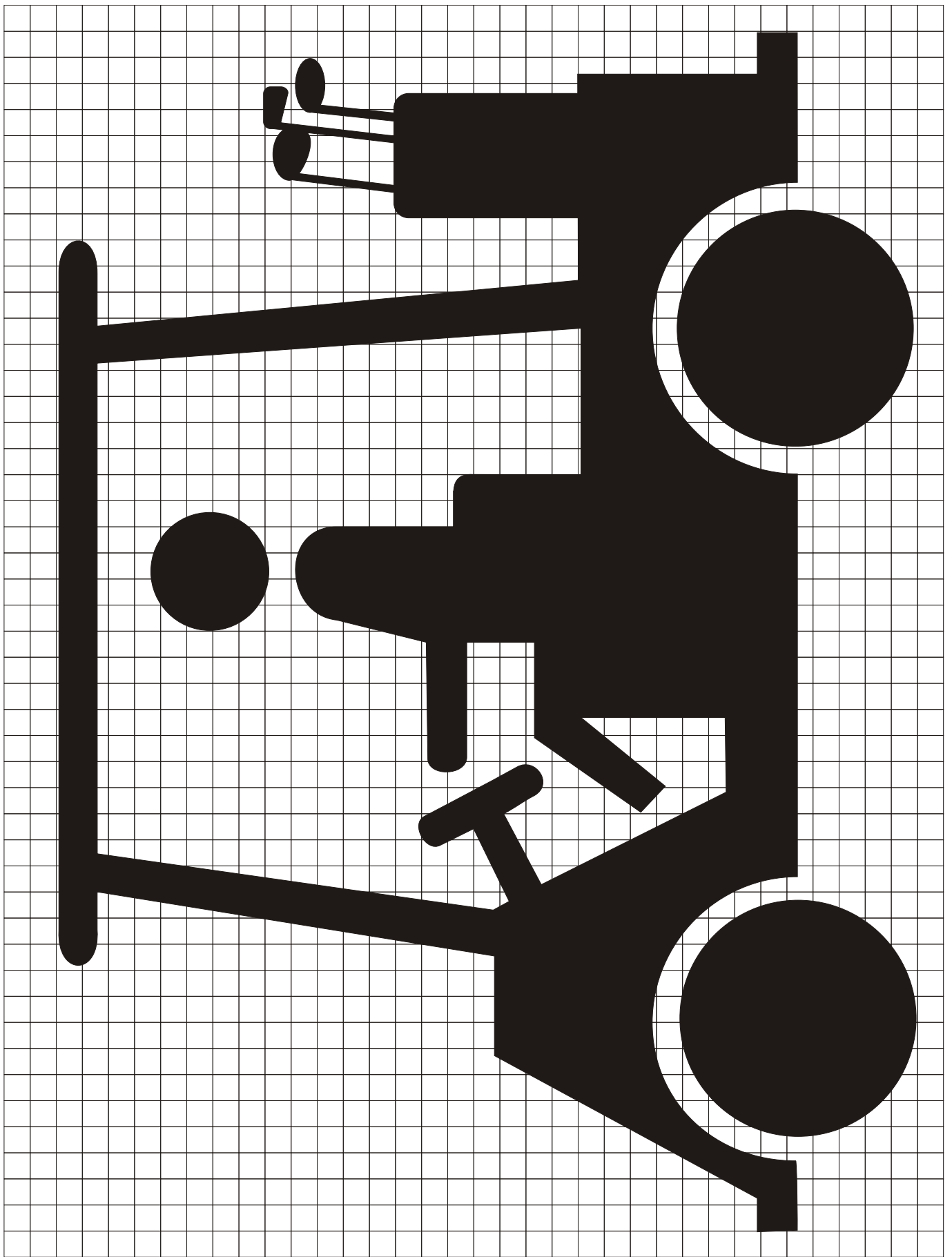

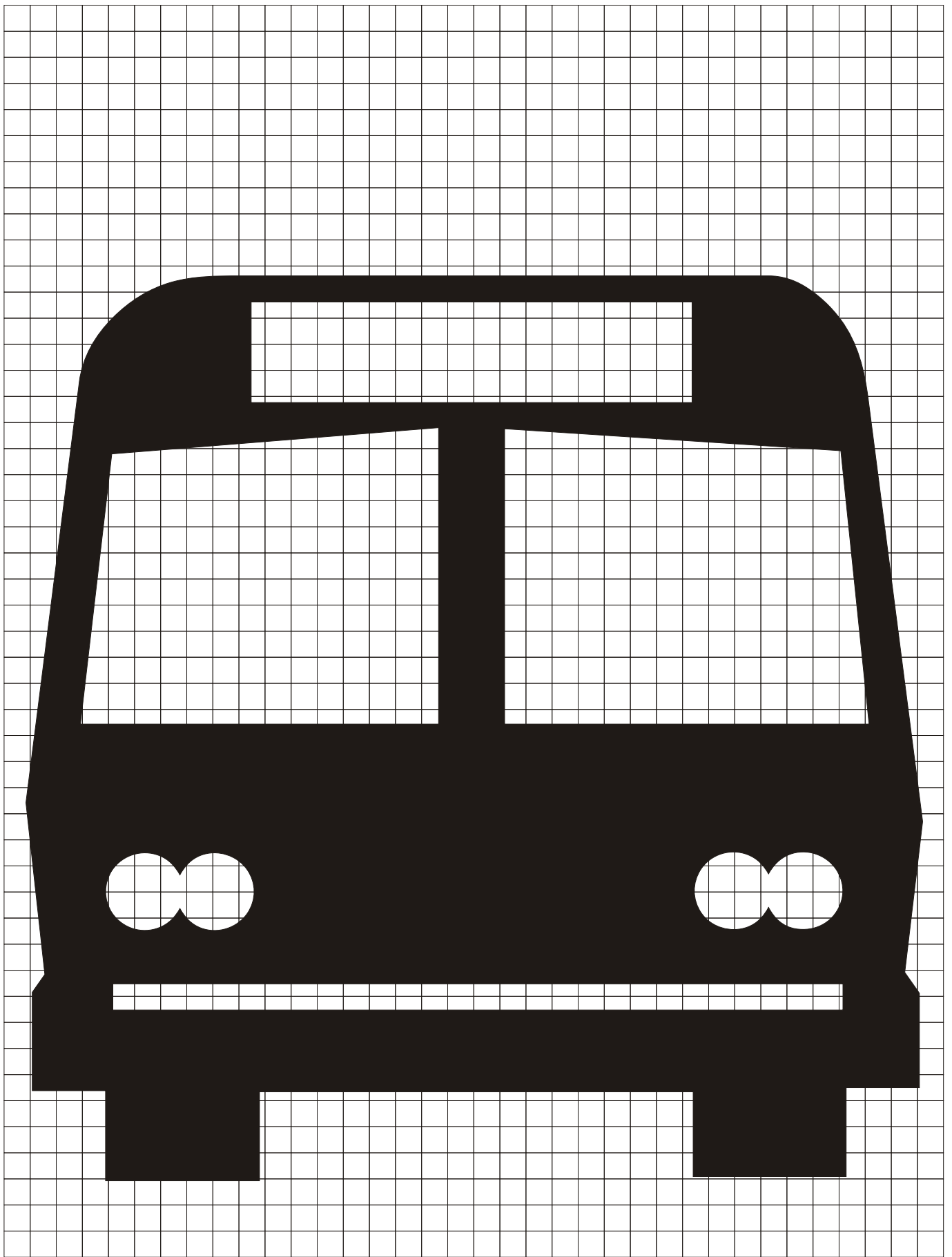

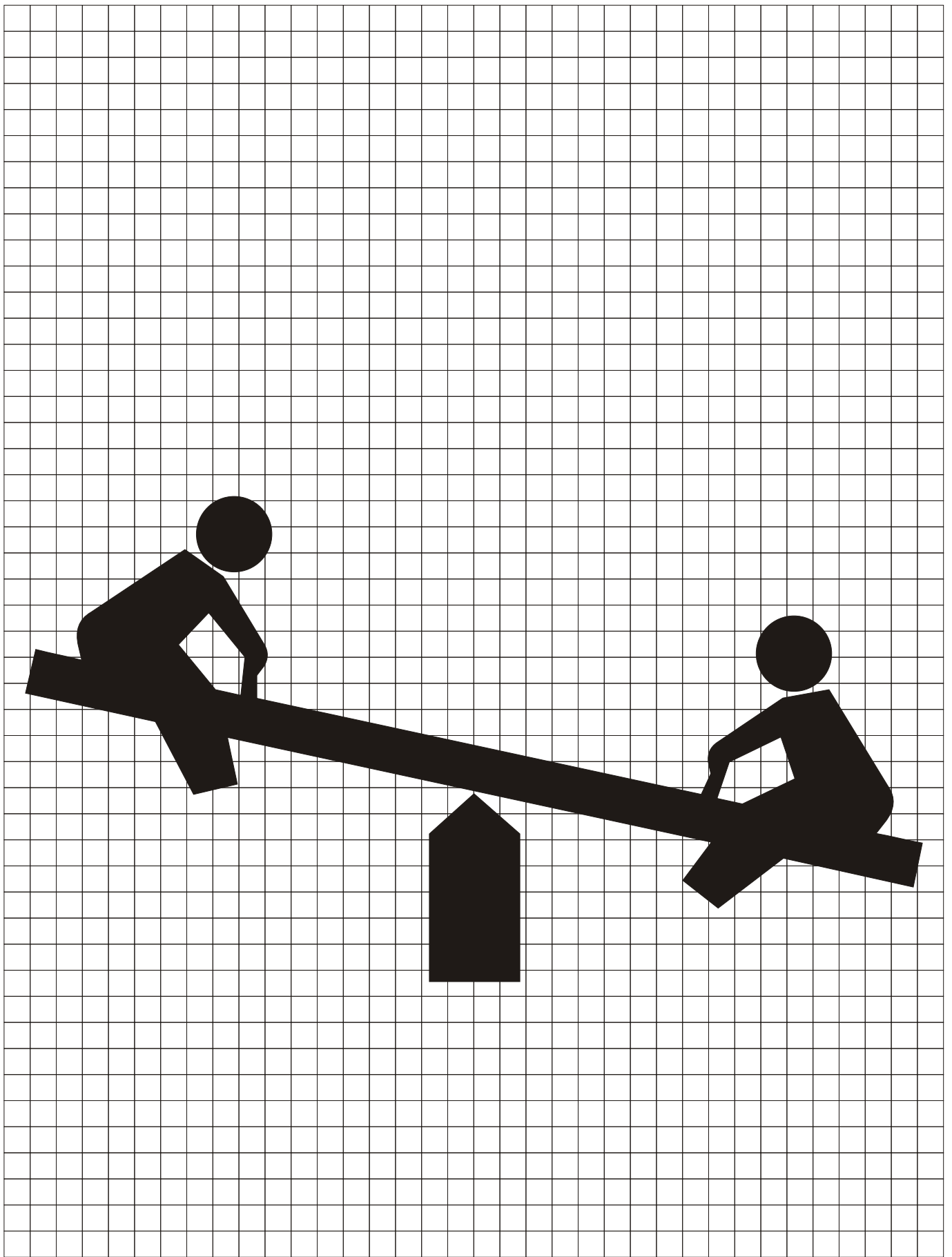

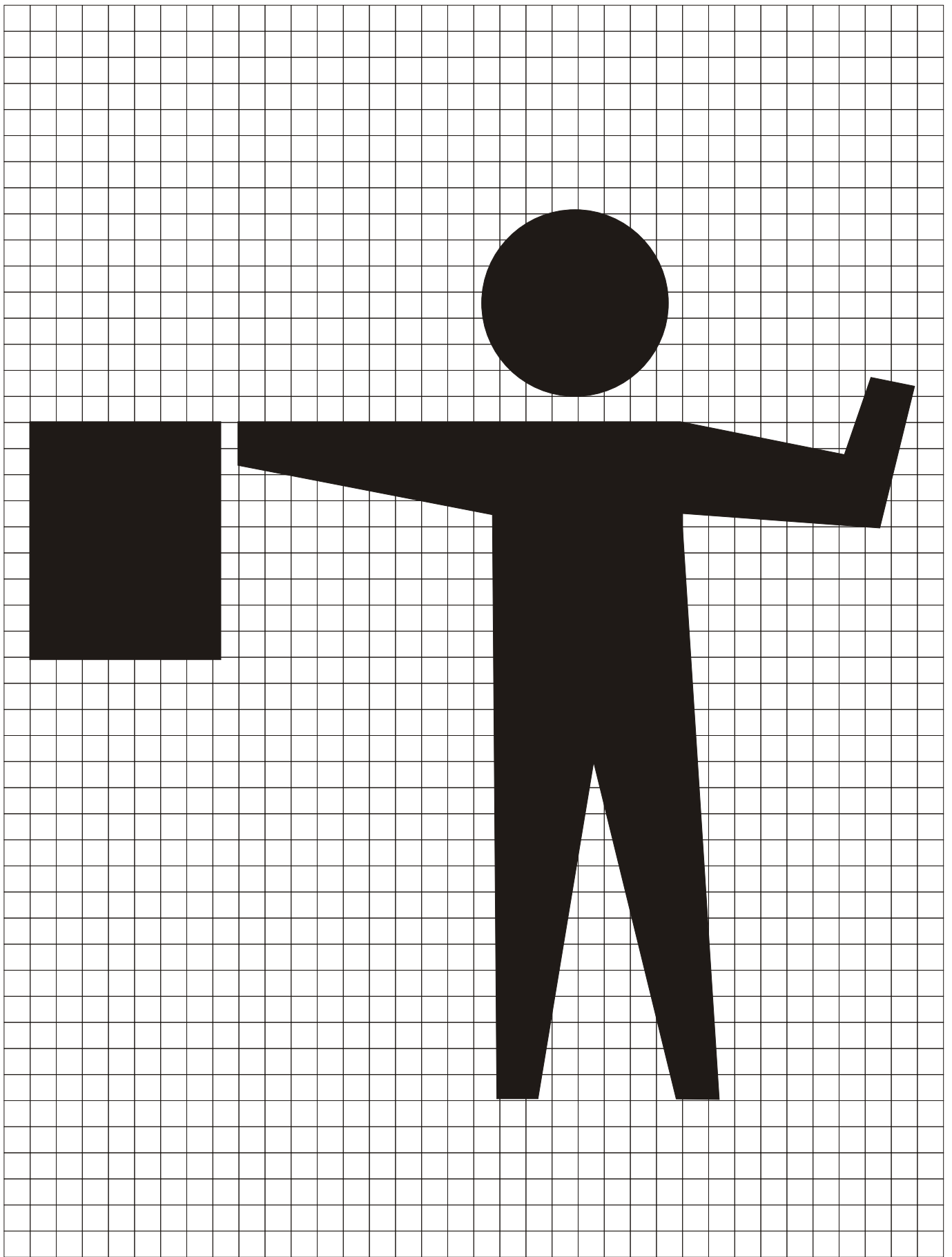

**National
Forests**

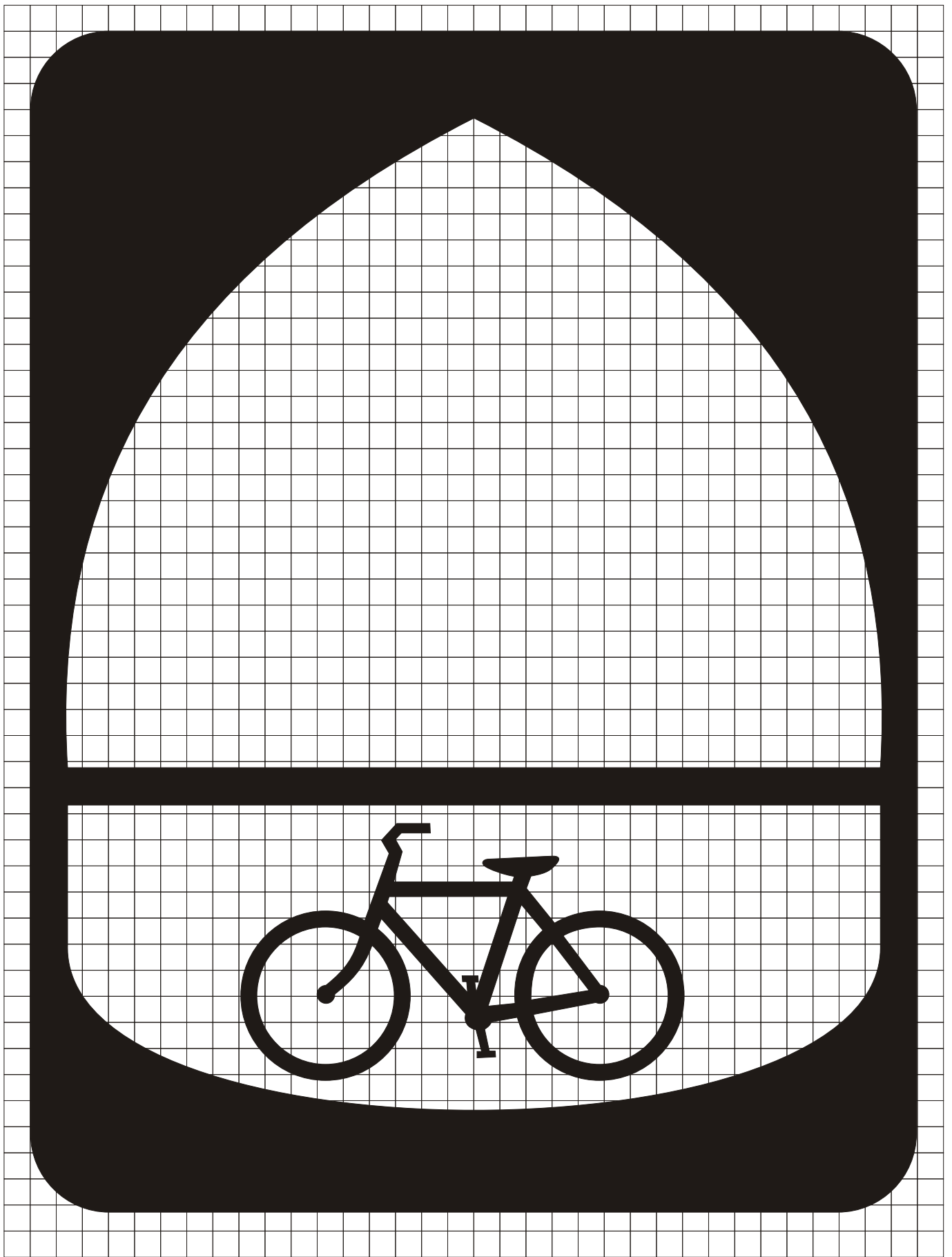

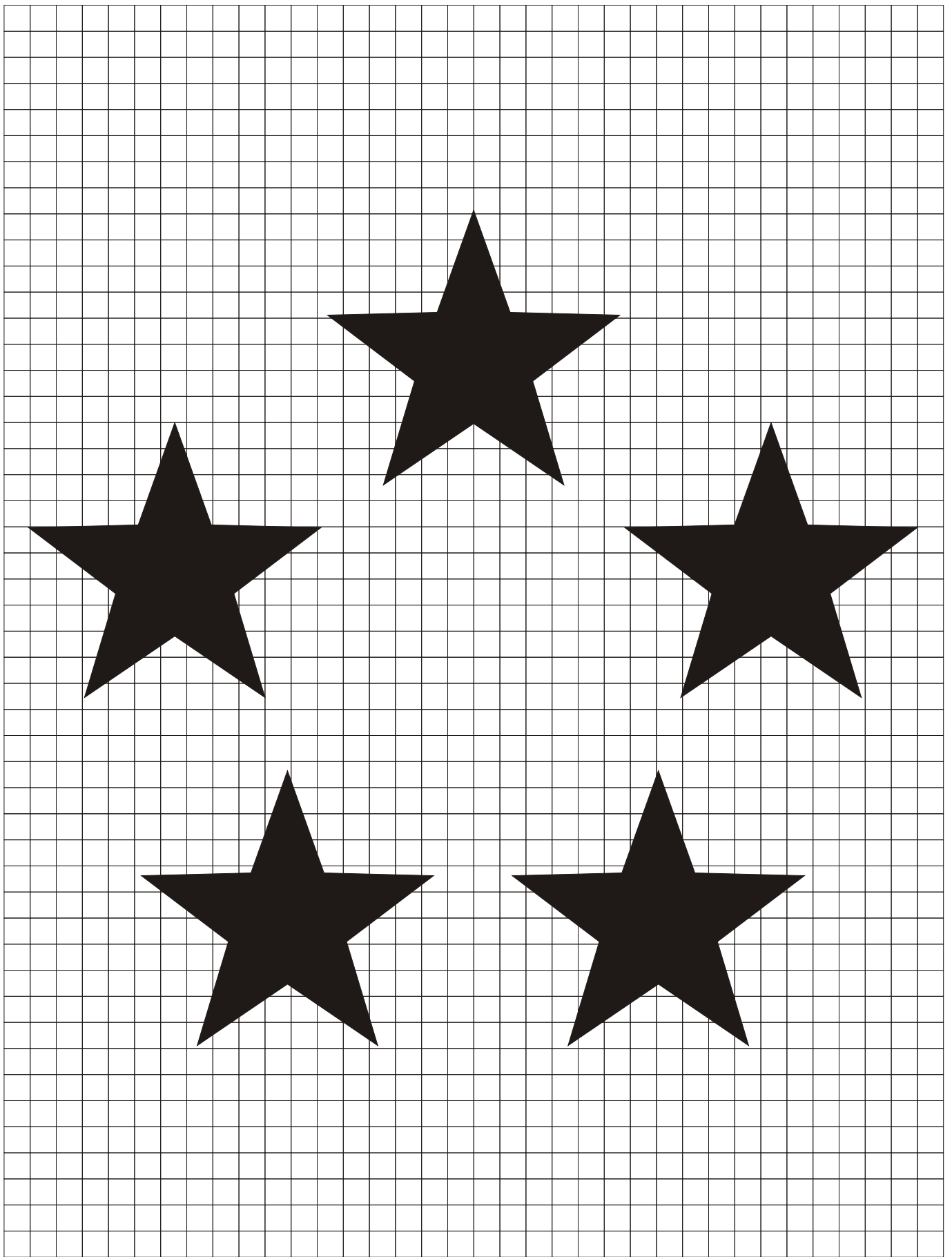

ESSENTIAL INTELLIGENCE SYSTEM

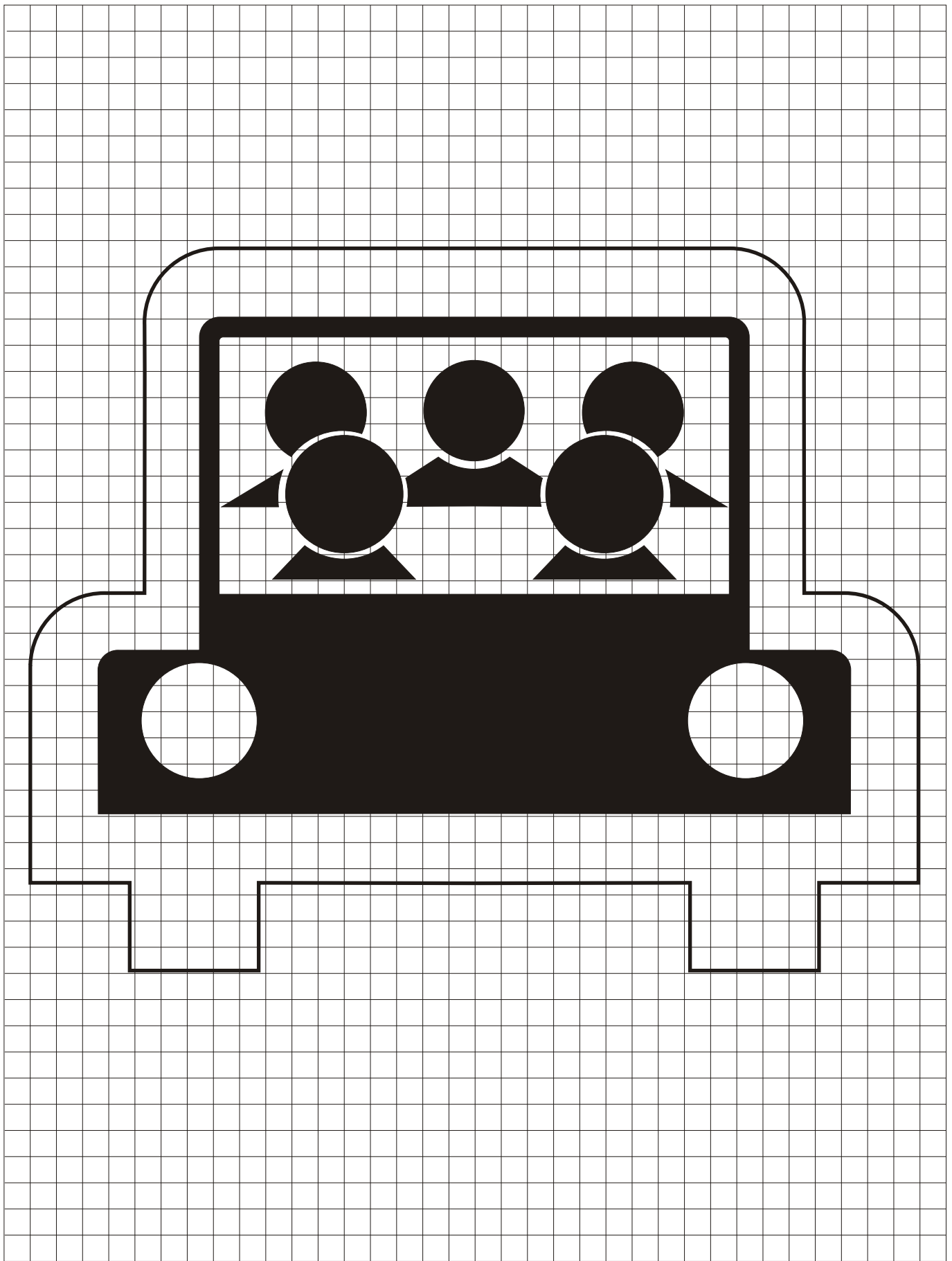

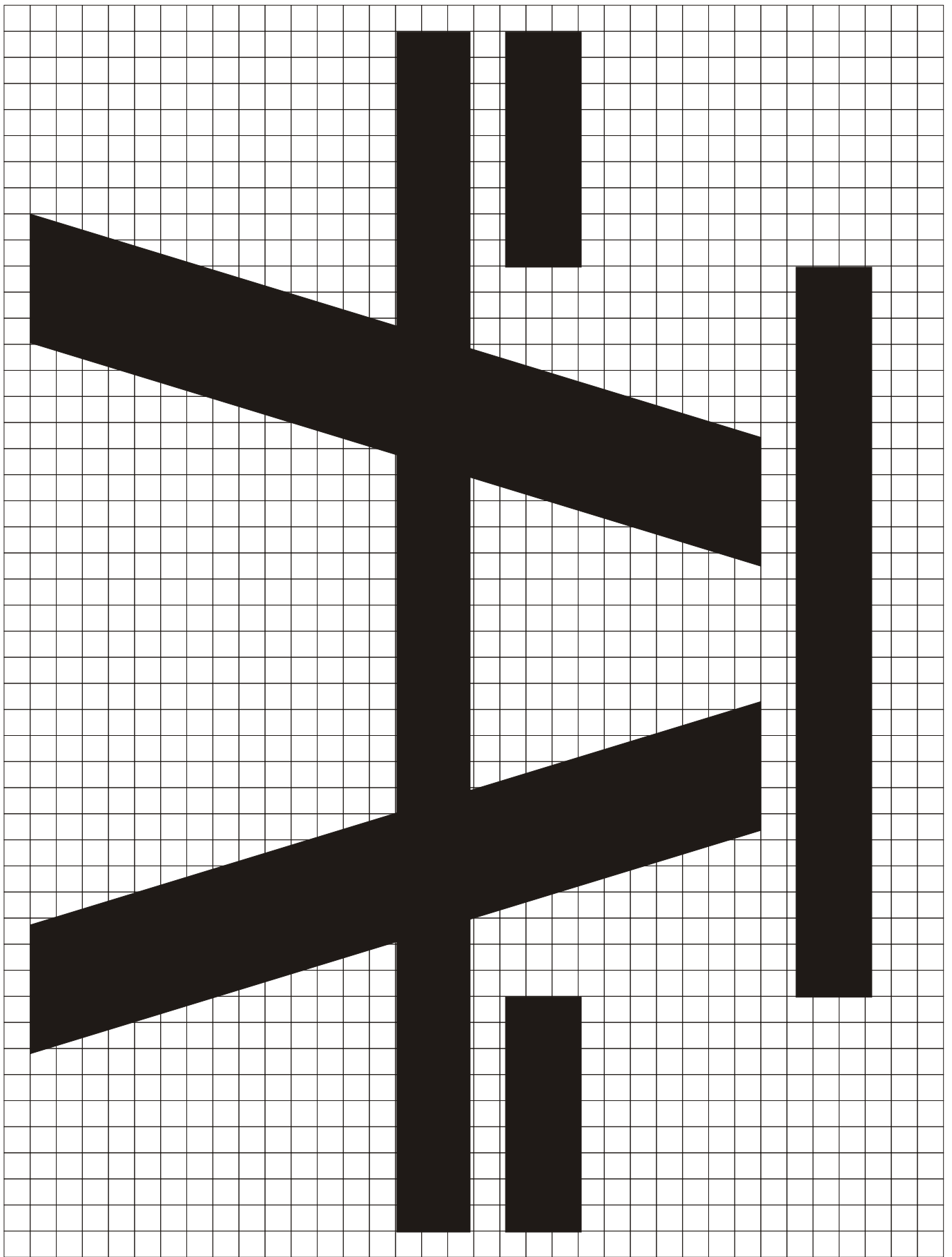

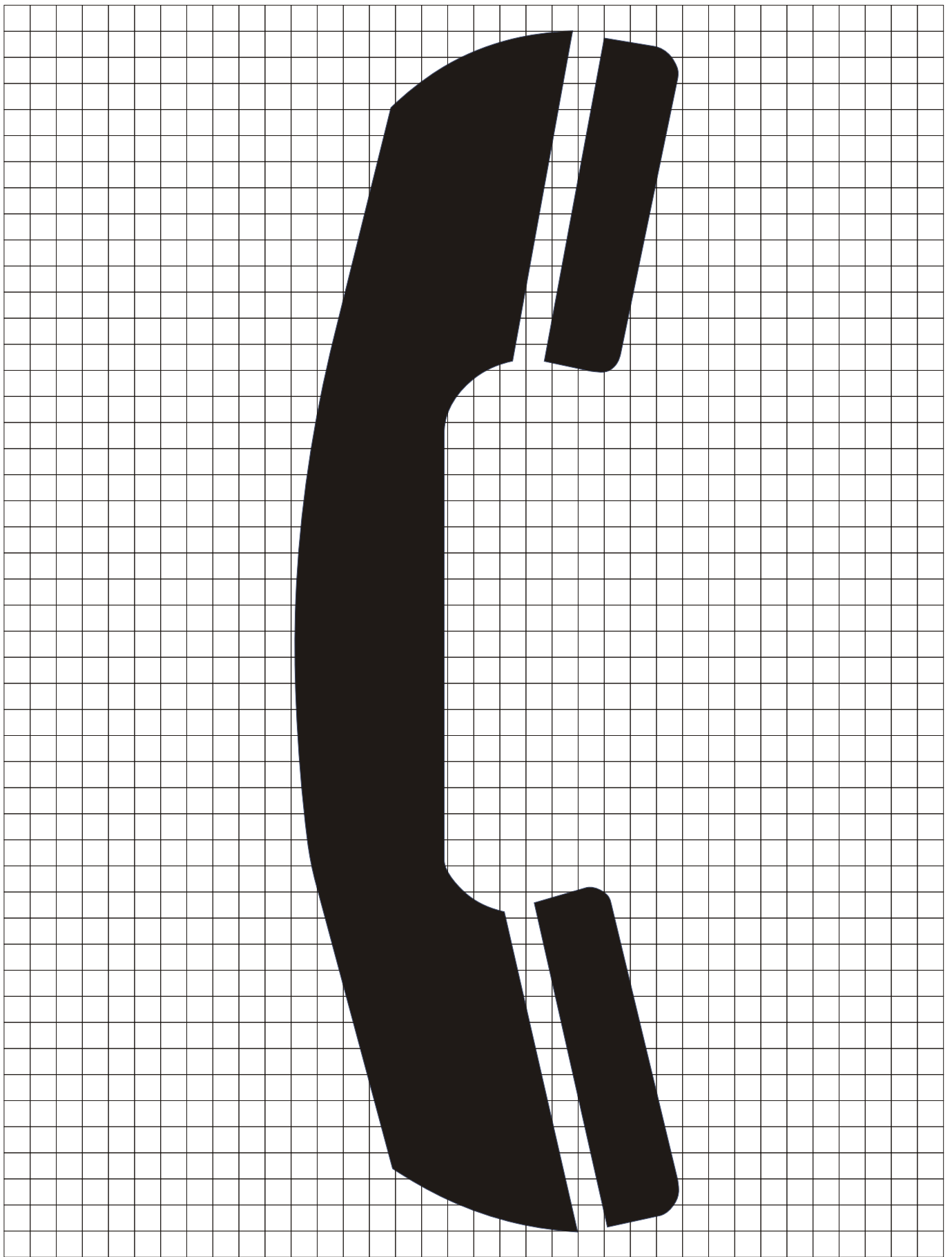

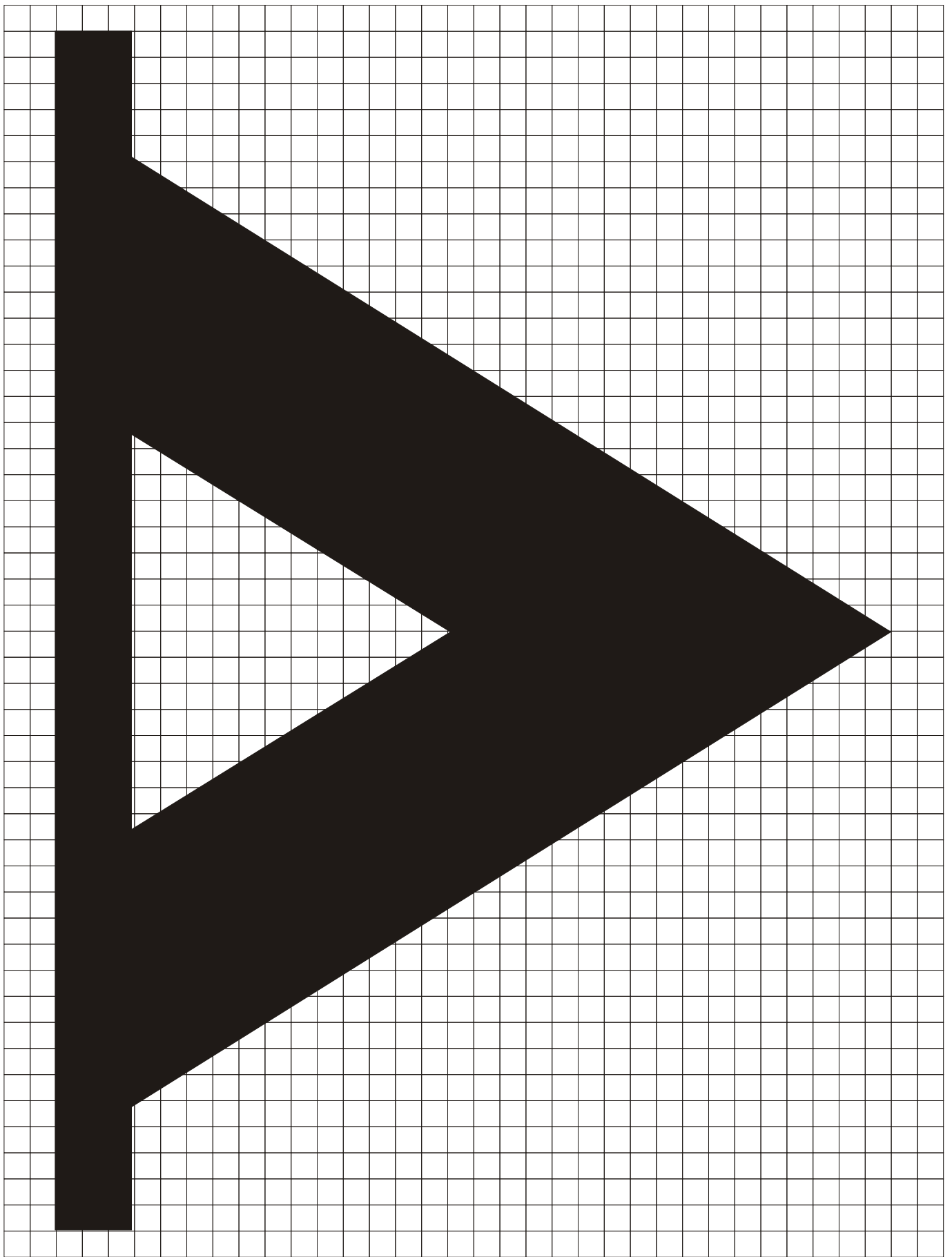

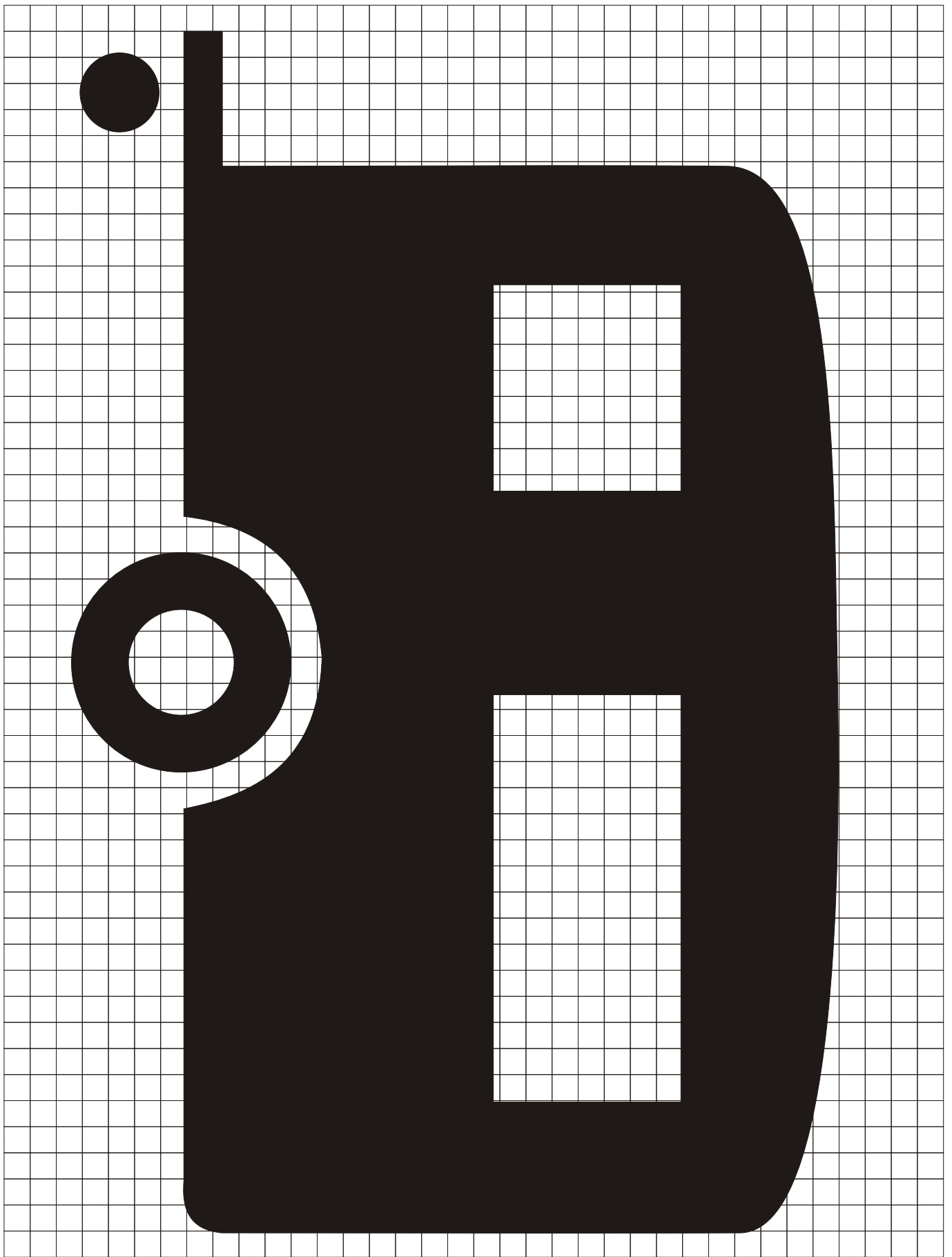

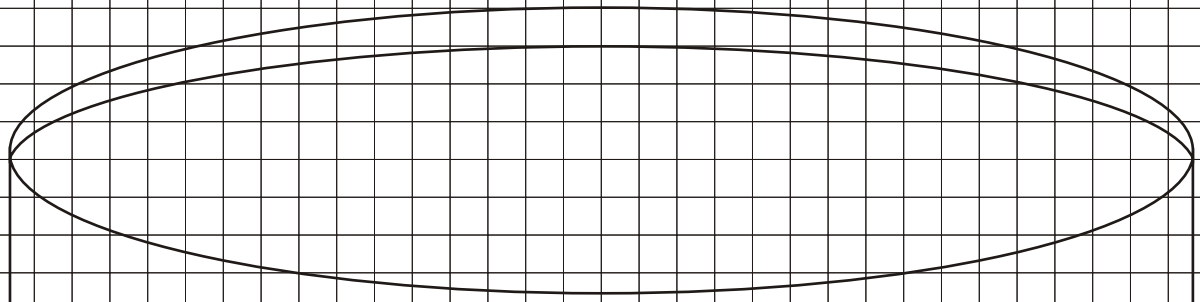

LITTER

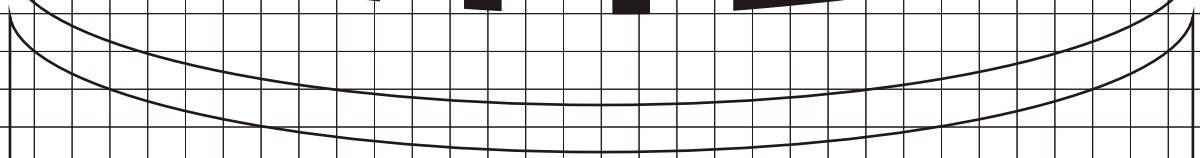

BARRREL

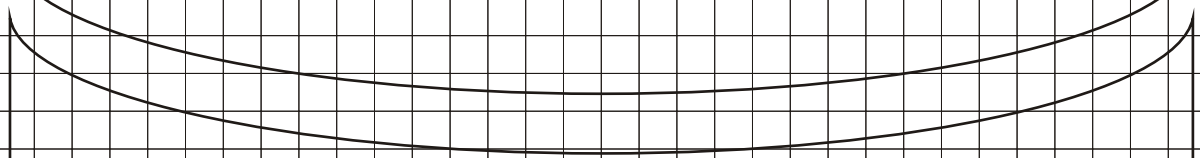

1000 FT

